

$E = I \times R$

$R = \frac{E}{I}$

$I = \frac{E}{R}$

CONDENSERS IN SERIES

$C_{TOTAL} = \frac{C_1 \times C_2}{C_1 + C_2}$

RESISTANCES IN PARALLEL

$R_{TOTAL} = \frac{R_1 \times R_2}{R_1 + R_2}$

# RADIO

ESTABLISHED 1917

## SHORT-WAVE AND EXPERIMENTAL

BOTTOM VIEWS OF SOCKETS

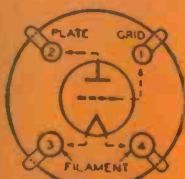

4-PRONG SOCKET  
50-201-A, 45, 210, 30, 31 ETC.

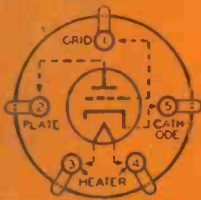

5-PRONG SOCKET  
56-46-47-76-27-37

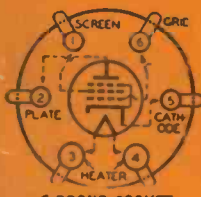

6-PRONG SOCKET  
2A5-41-42-43

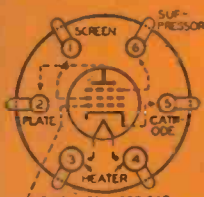

6-GRID-METAL TOP CAP  
6-PRONG SOCKET  
57-58-606-606-77-78

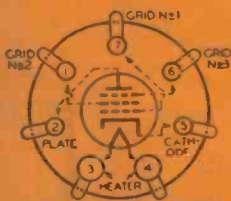

7-PRONG SOCKET 59

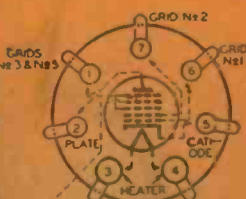

6-GRID No 4-METAL TOP CAP  
7-PRONG SOCKET  
2A7-6A7

- IN THIS ISSUE -

A New Plan for Protecting Amateur Privileges

Push-Pull vs. Parallel Operation, Part II

Auto Interference Elimination for 5-Meters

Efficiency versus Power Modulation

Review of the New R C A - A C R Receiver

New Data On The 2B6 Les-Tet Exciter

Design Factors For Class A-Prime Systems



400 Watt  
Link-Coupled  
Amplifier  
Using the  
New 150-T.

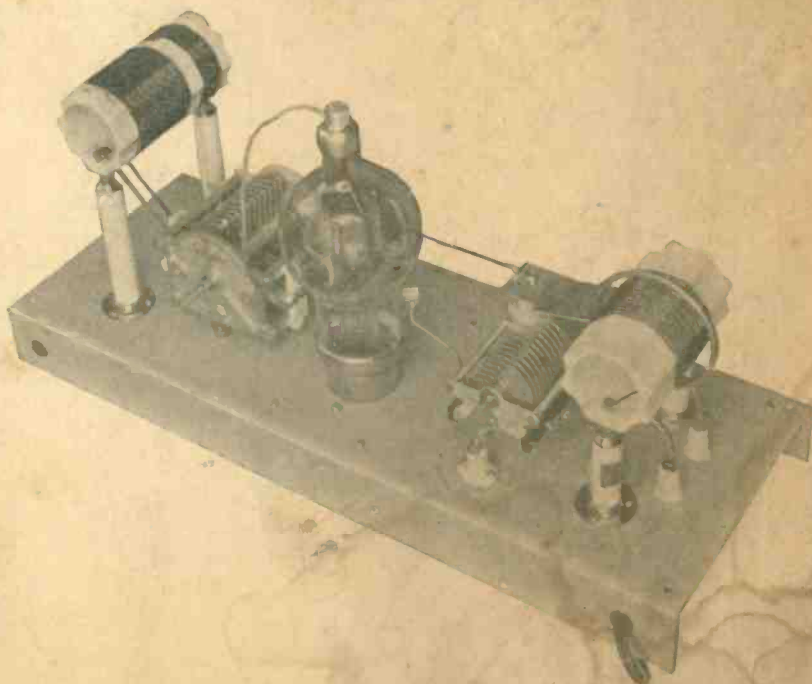

FEATURE ARTICLES BY ...

CLAYTON F. BANE  
NORRIS HAWKINS

- FRANK C. JONES  
- FRANK LESTER

- JOHN L. REINARTZ  
- I. A. MITCHELL

# \$500 REWARD!

## Sylvania



STARTS  
DEC. 4, 1934

### CONTEST!

ENDS  
FEB. 4, 1935

### PRIZES

- 1st 1-204A tube
- 2nd 2-860 tubes
- 3rd 2-852 tubes
- 4th } 2-203A tubes each
- 5th }
- 6th }
- 7th } 2-830B tubes each
- 8th }
- 9th }
- 10th } 2-830 tubes each
- 11th }
- 12th }
- 13th }
- 14th } 2-210 tubes each
- 15th }
- 16th }
- 17th }
- 18th }
- 19th }
- 20th }
- 21st }
- 22nd }

OBJECT — To gather the greatest possible number of QSL cards from other amateurs who are users of SYLVANIA GRAPHITE ANODE transmitting tubes.

THOSE ELIGIBLE — All licensed amateurs in the United States except Hygrade Sylvania employees. *It is not necessary that you have SYLVANIA transmitting tubes in your own transmitter in order to participate for prizes.*

REQUIREMENTS — The following information must be written on all QSL cards received from SYLVANIA tube users by the Gatherer in order to have them count in the contest.

1. Types of Sylvania tubes used.
2. In what stages used.
3. From whom purchased.
4. When purchased.
5. Time and date of QSO.

TIME LIMITS — Contest starts December 4th at midnight and ends February 4th at midnight. All QSLs must bear postmarks within these limits. Gatherers must send in their bundles of cards so that they will be received at our Clifton Plant on or before February 15th. Packages should be securely wrapped and carefully addressed to Hygrade Sylvania Corporation, Amateur Radio Division, Clifton, N. J.

REGISTRATION — To enter this contest all you have to do is to mail *one of your own* QSL cards direct to our Amateur Radio Division in Clifton, merely stating thereon "I desire to enter the QSL contest." For further details see or write to your nearest Specializing SYLVANIA Distributor.

*In case of a tie for any prize—the persons tying will each receive a prize.*

## HYGRADE SYLVANIA CORPORATION

ELECTRONICS DEPARTMENT  
AMATEUR RADIO DIVISION



CLIFTON



NEW JERSEY

© 1934, H.S.C.

New!

IT'S  
AIR  
TUNED

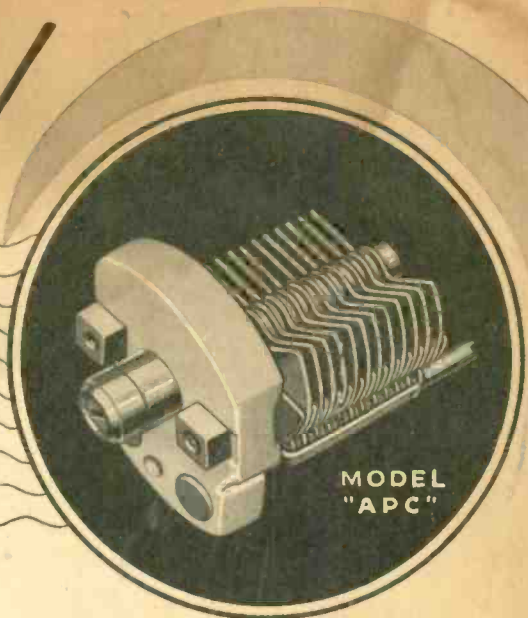

The  
**PADDING CONDENSER**  
They're All Praising!

**T**HERE must be a reason for the great popularity of this new Hammarlund Model "APC" Condenser. And this, we believe is it: Here is a compact condenser (*the 100 mmf size is only 1 - 7/32" x 15/16" x 1 1/2"*) which is not surpassed in mechanical and electrical efficiency. Because of its AIR DIELECTRIC, it will remain in constant adjustment, unaffected by changes in humidity or temperature, moisture absorption or vibration. Every amateur and experimenter will appreciate these qualities.

It is well adapted for short-wave and ultra short-wave work, tuning intermediate transformers, trimming R.F. coils or gang condensers, antenna tuning, fixed tuning of R.F. circuits or plug-in coils, and for padding purposes in general. It is designed to mount inside of shields, and the new Hammarlund Coil Forms.

Soldered brass plates, with phosphor bronze tension spring. Smooth bearings. Molded Isolantite insulation. Now available in four maximum capacities: 100 mmf, 75 mmf, 50 mmf and 25 mmf. Special capacities to order.

Hammarlund makes also other popular, high grade padders, trimmers and equalizers, with Isolantite or Bakelite bases and mica insulation.

LOW-PRICED,  
LOW-LOSS,  
HIGH-EFFICIENCY  
COIL FORMS  
AND COILS

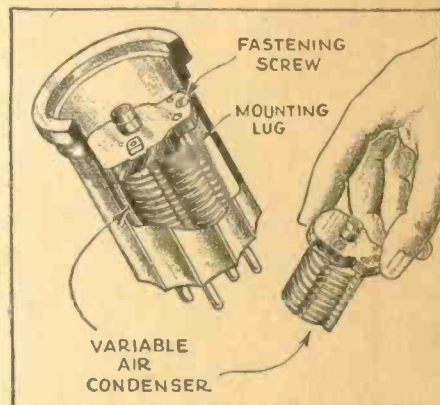

Mail Coupon for Catalog



HAMMARLUND MANUFACTURING CO.,  
424-438 W. 33rd St., New York

.....Check here and attach 10c for 16-page Hammarlund 1935 Short-Wave Manual, illustrating and describing most popular S-W circuits of past year, with schematic and picture diagrams and parts lists.

.....Check here for FREE information on XP-53 Coil Forms and Coils.

.....Check here for FREE General Catalog.

Name.....

Address.....

PR-12

# EIMAC Announces A Smaller Tube

A LITTLE BROTHER TO THE 150-T

50 Watts of Available Plate Dissipation . . . 30 Watts of Filament Power

## UNSURPASSED In Ruggedness & Performance

A low-C Triode designed to operate at all frequencies up to 300 megacycles (1 meter). The only 50-watt tube without a 1250-volt plate-voltage limitation. The high insulation and the X-ray vacuum permit the use of high plate voltage, although no practical benefit is derived if more than 3000 volts is used on the plate. Therefore, this tube can be operated at 300 watts input, provided the plate dissipation is not permitted to exceed fifty watts. It must be emphasized that high plate voltage is not required for efficient operation. The 50-T will operate at plate voltages of from 600 volts up, and is easier to drive to any given plate efficiency and power output than any other low-C triode with a plate dissipation of less than 150 watts. The performance of the EIMAC 50-T is just as outstanding at 600 volts plate voltage as at 3000 volts. Normally a type '45 or '46 tube as r.f. buffer-amplifier will drive the EIMAC 50-T to high output and efficiency. This tube is ideally suited as a buffer-doubler-driver for a final amplifier operating at 1 KW. input, in that it can use the same plate power supply that feeds the final amplifier.

### ● The Construction of the EIMAC 50-T Triode

All of the features listed in the table below are essential for efficient and long-life tube operation. The EIMAC 50-T incorporates all of these features. Check the features of any other tube against this list:

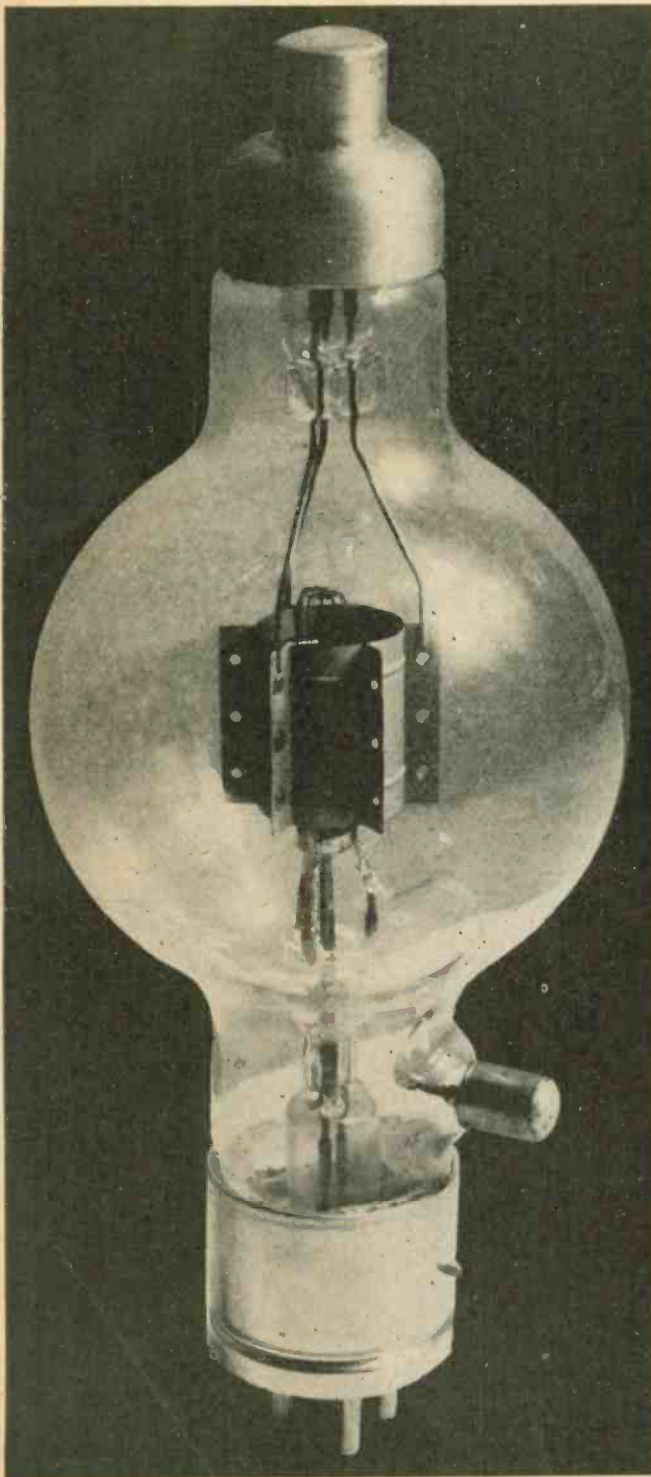

	Other Tube	EIMAC 50-T
(1) Has it a hard (NONEX) glass envelope?	<input type="checkbox"/>	YES
(2) Is it sufficiently gas-free to permit operation at 3,000 volts?	<input type="checkbox"/>	YES
(3) Have all internal insulators been eliminated to avoid breakdown?	<input type="checkbox"/>	YES
(4) Has the "Getter" been eliminated in order to prevent release of gas during momentary overloads?	<input type="checkbox"/>	YES
(5) Are the plate, grid and filament leads separated widely enough for high-voltage, high-frequency operation?	<input type="checkbox"/>	YES
(6) Is the plate-to-grid feed-back capacity less than 3 uufds.?	<input type="checkbox"/>	YES
(7) Can the plate be operated cherry-red without liberation of gas or damage to the tube . . . in other words, does it have a TANTALUM plate and grid?	<input type="checkbox"/>	YES
(8) Does it use 30-watts or more of filament heating power and have more than 3 amperes of peak filament emission?	<input type="checkbox"/>	YES
(9) Is 100 MA normal plate current conservative for the amount of filament watts utilized?	<input type="checkbox"/>	YES
(10) Does it use a vertical-bar grid in order to obtain high mutual conductance and ease of driving?	<input type="checkbox"/>	YES
(11) Is it unconditionally guaranteed for two years to remain gas-free and against break-down of the seals?	<input type="checkbox"/>	YES

"COMPARE AND REFLECT"

PRICE . . . . . \$12.00 NET

## EIMAC 150-T

THE EIMAC 150-T is already breaking records in amateur stations. Deliveries are being made in rotation as received, through our recognized distributors. Some of the reasons for the instant success of the 150-T are, (1) Over-size Filament, (2) X-ray Vacuum, (3) High Mutual Conductance, (4) Ability to Withstand Momentary Overloads, (5) Lower Excitation Requirements. A typical 1-KW link-coupled tube lineup consists of a 47 oscillator, 45 buffer, EIMAC 50-T buffer and two EIMAC 150-T tubes in the final amplifier, the last two stages operating from a common 2500 volt power supply. Thus it is evident that efficiency and economy work hand in hand only when EIMAC tubes are used.

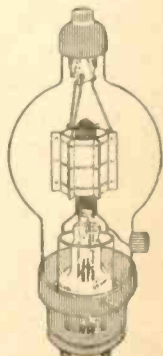

PRICE . . . . . \$24.50 NET

Order Through Your Dealer

## Eitel-McCullough, Inc.

SAN BRUNO, CALIFORNIA, U. S. A.

### CHARACTERISTICS

EIMAC 50-T	150-T	EIMAC 50-T	150-T
Filament Voltage 5V	5V	Rated Plate Dissipation . . .	50W 150W
Filament Current 6A	10A	Amplification Factor . . . . .	13 13
Filament Watts 30W	50W	Normal Max. Plate Current . .	100MA 200MA
Plate Voltage 1000	POWER OUTPUT . . . . .		75W 150W
Plate Voltage 2000	(75% Eff.) . . . . .		150W 300W
Plate Voltage 3000			250W* 450W
* At 83% Plate Eff.			

BRANCH OFFICES:  
 New York City,  
 253 W. 128th St.  
 Tel. MOument 2-2812  
 Boston,  
 J. H. Condon,  
 6 Marlboro St.  
 Chicago,  
 C. W. Nelson,  
 3618 North Bernard St.  
 Los Angeles, Calif.  
 1455 Glenville Drive.  
 Tel. CRestview 4017

# RADIO

ESTABLISHED 1917

Reg. U.S. Pat. Off.

A NATIONAL MAGAZINE - PUBLISHED MONTHLY

Publication Offices—Pacific Building, San Francisco, California

Clayton F. Bane, Editor  
 D. B. McGown, Technical Editor. Frank C. Jones, Ultra-Short-Wave-Engineering Editor.  
 Clair Foster, Amateur Activity Editor. George B. Hart, Contributing Editor.  
 H. W. Dickow, Business Manager.  
 C. C. Anderson, Engineering Draftsman

25c per copy, \$3.00 per year by subscription in the U.S. \$4.00 elsewhere. Send subscriptions to the San Francisco office. Entered as second class matter at the Post Office at San Francisco, California, under the Act of March 3rd, 1879.

Vol. 16

DECEMBER, 1934

No. 12

## RADIOTORIAL COMMENT

### ★ ★ The Eighteenth Year

WITHOUT the crash of cymbals, without the blare of trumpets, but with pardonable pride, the publishers of "RADIO" announce the beginning of the eighteenth year of successful publication. "RADIO" was born in 1917. It has survived two major depressions. Its growth in the past year has been satisfactory. The kind words of encouragement from readers and subscribers are appreciated. Likewise is acknowledgment made of the receipt of a large number of highly-constructive letters of criticism.

The words of those who praise us are weighed against the words of those who damn us. There is but one barometer to guide us . . . the voice of the sane-thinking majority! Twice as many copies of "RADIO" are now sold as were sold a year ago. Four times as many people have subscribed for it. Three times as many manufacturers advertise in it. Many dealers report that "RADIO" is the fastest-selling magazine in its field. For which we have only you, the reader, to thank. We will continue to give you first-run releases on important new technical developments; we will publicize the worthy achievements of ANY manufacturer, large or small.

Our political platform remains unchanged. We will expose the tricks of those who are working against the best interests of amateur radio.

Right is might! Selfish interests have brought pressure to bear to force us to change our policy. The political columns of this magazine, like a woman's honor, are not for sale.

### ★ ★ A Handbook by "RADIO"

SOON we will announce the publication of our first handbook. Advance publicity given the book by a friendly contemporary has brought an avalanche of pre-publication orders. Those who have so generously expressed their faith in us are asked to "sit tight" for just a little while; our big book is on the "ways" and will soon be launched. The principal reason for the delay in publication is the mere fact that we insist upon making the book absolutely up-to-date and down-to-the-minute. Three new amateur

tubes are coming, two of them sensational in design. They will not make obsolete any equipment on the market today; you can use the tubes in your present transmitter. The new circuits for 1935 model amateur receivers are of more than ordinary interest. Micro-wave transmitters and receivers are going places. 20-meter crystals hold real promise. High-fidelity audio systems are arousing considerable interest. Directive antennas are putting R9 signals into distant places.

With these and other red-hot developments in the offing, it was deemed wise to wait for all of the new things for the amateur before our handbook is put on sale. 99% of the text for the book is already written and has been set in type. As soon as we get the "go" signal from those who make the news, the handbook will be offered to you. It will be the largest and most authoritative work of its kind ever released for the amateur.

### ★ ★ Don't Be Misled!

CONTRARY to what you may have been told, your subscription money for "RADIO" is literally as safe as the Rock o' Gibraltar. When you spend your hard-earned money for a subscription, the money is deposited in a bank which is a member of the Federal Reserve system. Each month, slightly more than 8% of it is withdrawn. Your money is spent, proportionately, after you receive your copies of the magazine. We do not gamble with your money, we gamble with our own. All of the subscription moneys received from all subscribers to this magazine can be refunded in full at any time on demand. This policy was established when we started publication eighteen years ago.

### ★ ★ Scoops!

A "SCOOP", or a "beat" is something every newspaper or magazine publisher likes to print in his pages. Many of the worthwhile scoops originate in the laboratories of the more-important radio manufacturers. Although some of these scoops are regarded as out-and-out publicity write-ups for the manufacturers, they are of such timely interest that they must be publicized because they are often the means of completely revo-

lutionizing some phase of the art. In the laboratories of many of our radio manufacturers you find a group of engineers recruited from the amateur ranks. These engineers will always be amateurs at heart. When they develop something of a timely nature they unselfishly hasten to release the findings for publication. The exclusive feature releases from a select group of manufacturers fortunately come to this magazine. A manufacturer need not advertise in these pages in order to secure editorial recognition. Some of the best information has come from those who have not the slightest idea of ever advertising in "RADIO".

We do not single-out a "preferred" manufacturer and clutter our pages with publicity and parts specifications of his brand alone.

### ★ ★ QSL Cards Put Hinds Out of Race for Directorship

MR. FRED J. HINDS of Chicago, whose candidacy for appointment to the ARRL Board of Directors was sponsored radiotorially in November "RADIO", has informed this magazine that he has been ruled out of the race by the ARRL Executive Committee because he is commercially engaged in the "selling of things" to the amateur. Fred J. Hinds is a commercial printer and sells a few QSL cards now and then. Thus a straightforward, honest, sincere and courageous business man, one of amateur radio's outstanding champions, has been forced to sit on the sidelines for fear that the Board may become "tainted", should a catastrophe such as the election of a QSL-card-maker befall the League.

Fred Hinds does not object. He abides by the ruling of the Board as a gentleman and asks this magazine therefore to sponsor the candidacy of W9SG, Mr. Lane Eldred of Carrollton, Illinois. "He is in accord with my views," says Hinds, "and he is alert, young and spirited—with amateur radio at heart." Those who have not previously known the sportsmanlike qualities of Mr. Hinds are now better informed. Thus this magazine cheerfully accepts the suggestion that the amateurs of the Central Division throw their support to Mr. Lane Eldred. He comes to you recommended by Mr. Hinds, and there seems to be nothing that we can add to strengthen the recommendation of a gentleman.

# How Long Must We Continue to be Mis-informed?

By CLAIR FOSTER, W6HM

HERE lies before me a letter from the ARRL to an amateur. It is misinforming in general and, besides, contains one glaring untruth in an essential particular. Within the past few months several letters have been sent to me of the same origin and similarly misinforming. Now, if half a dozen such letters are delivered into my hands it goes without saying that hundreds are written that I never see. So the sum total of mass misinformation thus disseminated must be enormous.

I quote from the one before me. "Of course, as you know, all voting in ARRL affairs is now restricted to licensed amateurs."

The action of the ARRL directors on May 15, 1934, prescribed that non-amateurs admitted to membership after that date would not have their ballots counted. That means that such new members will receive blank ballots but if they use them for the purpose for which they are sent the ballots will not be counted. A queer piece of hokum, this resolution, for handing a member a ballot justifies the member in believing he has the right to exercise it. It is, to say the least, a disingenuous resolution. Its lack of frankness is obvious. The open and aboveboard way to have put it would have been, "Non-amateurs who subscribe to QST after May 15, 1934, will not be members of the ARRL". The man who framed the resolution devised it as a sop to the amateurs who are objecting so strenuously to the practice that has been going on ever since 1920 of admitting to membership all of the commercial radio people and other non-amateurs who have been subscribing to QST. And at the same time the framer of the resolution worded it in such a way as not to scare off the prospective non-amateur subscriber who might be regarding membership in the ARRL as an inducement. The legality of the resolution is just as questionable as its sincerity, for the act of giving a man a ballot presupposes that he is lawfully entitled to exercise it.

At any rate, the writer of the ARRL letter that lies before me knows perfectly well that the resolution affects not all the thousands of commercials and other non-amateurs admitted to membership in the 15 years prior to May 15, 1934—that all of these non-amateurs still vote.

These headquarters men are especially careless in their handling of the truth. On occasion they twist and re-mould it until it is far from its simple verity of form. It may still resemble the truth in some respects but it has been distorted for the purpose of deception and, therefore, is no longer the truth. If this statement of mine is challenged I will produce examples from the written and printed matter issuing from ARRL headquarters. Of course these deceptive half-truths fool many people for the simple reason that they look like the truth. If a lie didn't LOOK like the truth nobody would believe it; and a liar would be a dumbhead indeed to tell one that nobody would believe. A lie depends for its acceptance upon one or both of two circumstances—its resemblance to the truth, (that is, its plausibility), or confidence in the trustworthiness of the narrator. Many amateurs who have read the May resolution are unaware of just what it signifies. Many haven't read it at all. Many who have read it are so convinced of the utter truthfulness of the ARRL spokesmen that they will accept without question the glib misstatement, "All voting in ARRL

affairs is now restricted to licensed amateurs".

The letter peddles the same propaganda as other letters, as QST, and as the headquarters men who are sent out to hamfests and conventions to keep the rank and file "sold" on the fallacy that Hartford disregards the interests of the commercial members and works only for the amateur members—the propaganda that if the ARRL isn't wholly amateur then it is at most only 20 to 30 per cent commercial. In this connection here is something you will enjoy. (If you have heard this one, stop me.) Hebert at Vancouver, British Columbia, in August, went so far as to say he would "guarantee" that over 50 per cent of the 35,000 licensed amateurs of the United States are members of the ARRL. I had this at the time from two of the older members of the Vancouver gang who had copied verbatim many of Herbert's statements. In other words, Hebert announced that over 17,500 of the present 20,000 members of the ARRL are licensed amateurs of the United States! And he is one of the three highly paid employees of the ARRL who make up the controlling majority of the Executive Committee that establishes vital policies and directs major activities for a year at a stretch!

These wild statements are all desperate attempts to divert the minds of the amateurs from their demand for an actual COUNT of the United States amateurs in the ARRL. We, as part owners of the ARRL, Inc., are entitled to the information, and the mere fact that headquarters fights so hard against divulging it should convince anyone that there is something rotten in Denmark.

Even if only a few commercial radio people had been installed as members and part proprietors of the ARRL, the notion that these people do not influence the headquarters policies and actions is decidedly erroneous. Even if—as headquarters claims—only a few of these people exercise their right to vote for directors, or in fact if none of them at all vote, there is no truth in the statement that they exert no influence. They don't NEED to vote. If they can influence the men who control the ARRL they have amateur affairs in their own hands infinitely more to their own advantage than if they controlled an entire board of ARRL directors. This is a truism with which every business man is quite familiar—keep your hooks on the man who runs the job, never mind the bosses who are on the job only once a year.

As for this "70 to 80 per cent amateur" myth let us look at the stenographically recorded minutes of the ARRL directors' meeting of Dec. 8, 1923, when Warner, Hebert and Schnell were all directors. These minutes likewise are before me. They say:

Mr. Hebert: "There are now 16,000 licensed amateurs in the United States. We have 14,000 members in the League. It has been figured that 10,000 of these are licensed amateurs."

The Traffic Manager: "Ten thousand of which?"

Mr. Hebert: "Ten thousand of our members are licensed amateurs."

Mr. Bidwell: "I don't believe it."

The Traffic Manager: "It is less than 20 per cent."

The subject was dropped without one more word. That was 12 years ago, and the non-amateur proportion has been increasing steadily ever since. How nearly right was Schnell's

guess nobody knows, but it is significant that none of the officers or directors has ever taken the only means of refuting Schnell's assertion—going over the membership list and actually separating the amateur members from the commercial members. Nobody challenged Schnell's assertion at the time. Nobody has challenged it since until Warner did so in these words: (See them at the bottom of second column, page 36 of QST for June, 1934). "We have seen it suggested that ARRL is four-fifths a non-amateur association—that less than 20 per cent of ARRL members are licensed amateurs. This is sheer twaddle".

It needs more than the exclamation of a Warner to disprove the statement of a director in a board meeting when that statement has gone unrefuted for 15 years. Schnell was one of the insiders. He was the only headquarters man besides Warner who was drawing commissions in addition to his salary. He is an acute man and was exceptionally well informed on ARRL affairs. So we shall all accept Schnell's declaration until a count is made and the truth disclosed. We want to know just how much of a majority ownership of the ARRL, Incorporated, was brought about by the unauthorized action of 1920 that contrived an enormous financial rake-off for Warner, that overthrew the League as an association of transmitting amateurs and established it as a commercially influenced publishing business that thereafter was managed to provide high salaries for insiders.

The ARRL letter before me says, "You may be interested to know that prior to his departure for Lisbon, Warner engaged in considerable discussion with the Federal Communications Commission in the effort to get them to make an accurate and authoritative check of the percentage of licensed amateur membership in the League. These negotiations have naturally lapsed in his absence but there are hopeful indications that such a check may be made after he returns. If the check is made the results will of course be published."

From which the inference to be drawn is, if the FCC, a government bureau, does not see fit to spend the taxpayers' money doing a job that is purely the concern of a private corporation, the ARRL, then there is simply no way of finding out how many amateurs there really are in this corporation that advertises month after month that it is "a non-commercial association of radio amateurs"!

The letter closes with, "If you have any further information you desire we will be glad to supply it". After the exhibition presented by the body of the letter itself can you imagine anyone's desiring more "information" of the same kind!

Now, I am quite aware that this article will bring down upon my head cries of "destructive criticism". It is always those who cannot meet criticism who try to switch the spotlight off themselves with the plaintive cry, "destructive criticism". I have no desire to change the minds of those amateurs who have a fixed belief in the sanctity of the word of Hartford. Nor have I the slightest hope of it. But I should like to see the intelligent and upright amateurs do their own thinking and determine for themselves whether it is safe to leave their future wholly in the keeping of men who make deception their continuing business.

(Continued on page 36)

# Push-Pull vs. Parallel Operation—Part II

By JOHN L. REINARTZ, WIQP

YOU will remember that there was to be a second installment to the discussion on Push-Pull vs. Parallel Operation of RF amplifiers. Although it should have been written long ago, you will forgive the author for the delay when you are informed that he had the opportunity and took advantage of it to make a trip to the west coast. The inspiration derived from the trip will be a help on future articles. To meet the west coast amateurs personally, to shake hands with them, and to say thank you to those who in the past have helped him enjoy amateur radio was one of the thrills that come so seldom to a man. There are great amateurs on the west coast, and they live in a great country.

The first installment (Radio, page 10, Sept.) gave the set-ups for the determination of negative grid voltages and RF grid voltages; the power loss in the grid circuits being a function of the grid resistance and the grid current as shown by a milliammeter. The test was to determine whether push-pull or parallel RF operation of a pair of tubes is correct from the standpoint of power lost in driving the grids. It was found that the only difference between the two circuits was that twice the RF voltage was needed for the push-pull connection and that closer coupling to the driver circuit was needed for the parallel connection. The grid-watt losses were the same in each case. No plate voltage was applied in the previous tests in order not to complicate the determinations. The effects of the application of plate voltage are considered in this installment.

Of the two ways to determine what the grid losses might be when voltage is applied to the plates of the 46's under test—namely, keeping the output constant and taking note of the grid power needed in the form of grid excitation, or keeping the grid power as well as the output constant and taking note of the power input to the plates of the tubes—the latter method was used. Keeping the grid losses constant allowed the use of the same resistor values and grid-voltage values as obtained in the previous test; keeping the output constant was almost a necessity in order to measure the output with any kind of accuracy.

Methods for measuring the output with a fair degree of accuracy were given considerable thought. Two methods were finally chosen, one to check the other. The first method used ten-watt lamps which were on hand and had been carefully checked to give equal brilliancy for equal applied wattage. A pair of these lamps was again checked for this test. One was placed in a wattmeter circuit—the voltage across the lamp could be regulated so that just ten watts was supplied to the lamp. The other lamp was placed in a tuned circuit and coupled to the tank of the tubes under test. With the standard, the first lamp, set for just ten watts, the output from the tubes was raised until the two lamps were of equal brilliancy as nearly as could be determined. The second way to check the output was to use a photo-electric cell, placed in such a position with respect to the plate-load lamp that a convenient reading could be adjusted on the meter connected to the photo-electric cell. Thereafter, this reading corresponded to just ten watts of plate load. A cardboard shield was placed between the standard lamp and the load lamp in order that the light of the former would not cause error. Also, since the test was per-

Plate Volts	Plate Ma.	Plate Watts Input	Plate Watts Output	Grid Volts	Grid Ma.	Grid Resistor Ohms.	Grid Watts
420.0	0.0500	21.00	10	-10	0.010	1000	0.1
420.0	0.0495	20.79	10	-20	0.010	2000	0.2
422.5	0.0491	20.74	10	-30	0.010	3000	0.3
427.5	0.0485	20.73	10	-40	0.010	4000	0.4
430.0	0.0480	20.64	10	-50	0.010	5000	0.5
432.5	0.0470	20.34	10	-60	0.010	6000	0.6
433.8	0.0465	20.17	10	-70	0.010	7000	0.7
435.0	0.0460	20.01	10	-80	0.010	8000	0.8
436.0	0.0455	19.84	10	-90	0.010	9000	0.9
437.5	0.0450	19.68	10	-100	0.010	10000	1.0

Table I—Results of Push-Pull Test

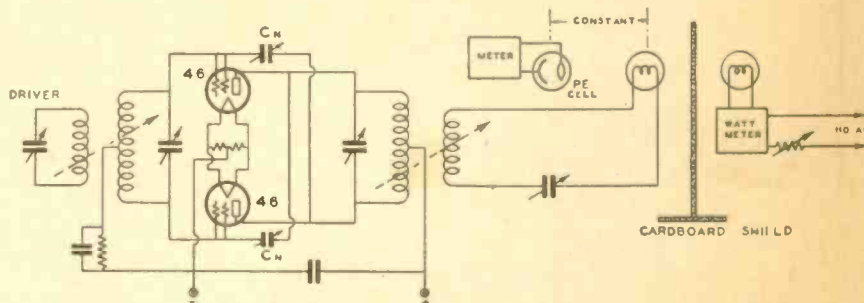

FIG. 3—Arrangement of Parts for Push-Pull Test

Plate Volts	Plate Ma.	Plate Watts Input	Plate Watts Output	Grid Volts	Grid Ma.	Grid Resistor Ohms.	Grid Watts
415.0	0.0435	18.45	10	-10	0.010	1000	0.1
418.5	0.0425	17.78	10	-20	0.010	2000	0.2
419.5	0.0420	17.65	10	-30	0.010	3000	0.3
417.5	0.0415	17.13	10	-40	0.010	4000	0.4
417.0	0.0410	17.10	10	-50	0.010	5000	0.5
417.0	0.0410	17.10	10	-50	0.010	5000	0.6
422.5	0.0405	17.30	10	-70	0.010	7000	0.7
430.0	0.0405	17.41	10	-80	0.010	8000	0.8
435.0	0.0405	17.62	10	-90	0.010	9000	0.9
445.0	0.0405	18.02	10	-100	0.010	10000	1.0

Table II—Results of Parallel-Connection Test

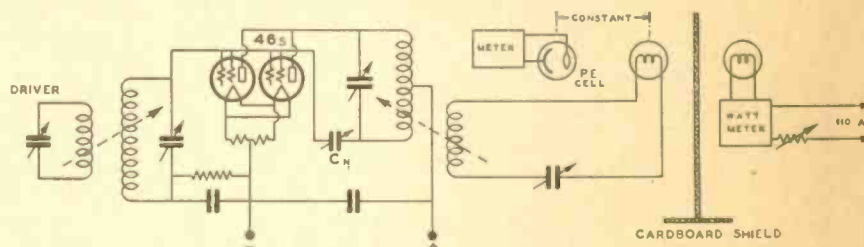

FIG. 4—Arrangement of Parts for Parallel-Connection Test

formed during the evening, it was possible to exclude other sources of light.

Having these two ways of checking the plate output, we are now ready to proceed with the test.

Our equipment now consists of a driver circuit, a tuned grid circuit with variable grid-resistor values from 1000 to 10000 ohms, a plate circuit with neutralizing condensers, and a wattmeter and photo-cell for measuring the output. The arrangement of the various parts is shown in Figure 3 for the push-pull test and in Figure 4 for the parallel-connection test. With everything in readiness, we start the driver and couple the tuned grid circuit to it, making coupling adjustments until the grid meter reads exactly 10 mills. We then apply plate voltage and

adjust the coupling between the load lamp and the tuned plate circuit until we have just ten watts for output. Some juggling of the grid coupling and the plate voltage is necessary to obtain just ten mills of grid current and ten watts output from the plate circuit for each resistor used. When the adjustment can not be made directly with a change in plate-load coupling, changes in the applied plate voltage can be made to take care of this adjustment without going below 400 volts or above 450 volts. The results of the push-pull are shown in Table I.

It will be noticed that a gradual increase in efficiency—the ratio of plate input to output power decreases—takes place while the grid losses, I<sup>2</sup>R losses at the grid resistor, are

(Continued on page 20)

# A Five-Meter M-O-P-A

By CLAYTON F. BANE

THE trend in ultra-high frequency equipment shows a tendency toward some form of master-oscillator, power amplifier combination. The reason is obvious; an increasing number of commercial, police and others are finding the ultra-high frequencies useful for their needs. The broad modulated oscillator type of transmitter must eventually give way to some form of driven amplifier circuits so that high percentage modulation with its attendant effectiveness can be utilized. Crystal control is far from impossible but it still presents so many complications that its use is hardly justified.

The advent of the new RCA 801 served as a stimulus for the construction of the transmitter here described. The 801 is driven by a '45. Although the internal capacities of the '45 tube leave much to be desired, it nevertheless makes an excellent oscillator for a five-meter transmitter and it is capable of delivering enough output to satisfactorily drive the 801.

The entire unit, which includes oscillator, amplifier, modulator and two power supplies,

essential difference is in the use of small condensers (low C being used throughout, except in the oscillator), and the use of small diameter inductances. Isolantite sockets are used for both oscillator and amplifier to lessen the loss, which is always appreciable at these frequencies. Shunt-plate-feed is desirable in the amplifier in order to keep the DC off the tank coil, and in the transmitter here described shunt-feed made for correct neutralization. In practice, either inductive or conductive coupling to the antenna is used. Both systems have their advantages, as well as their disadvantages. Inductive coupling was used because of its flexibility and ease of handling.

Good quality of reproduction, as well as a high percentage of modulation was demanded and, therefore, the audio system was designed to conform to these requirements.

Because the transmitter has a 20-watt carrier, it was necessary to use class B audio in order to provide the necessary 10 or 12 watts of audio to give 100 per cent modulation. If properly designed and good trans-

formers are used, the 53 makes a good class B tube. As the circuit shows, one 53 is used as a push-pull, class B tube, and another 53 with both sets of elements in parallel is used for the driver tube. The crystal microphone was approximately 60DB down and it was found a stage of 56 was not enough to bring the level of the mike up to a satisfactory value. Consequently, a 57 high-gain amplifier was used. When a 57 is used, all circuits must be well by-passed and under no circumstances should less than 12 mikes be used in the cathode resistor bypass. If a smaller condenser is used, degeneration and subsequent loss of the low frequencies will result.

The O-100 milliammeter is connected permanently in the positive high voltage of the class B amplifier. This meter is helpful in determining correct setting of the gain control and assures the operator that the modulator and speech amplifier stages are working properly. An O-1 meter in conjunction with a Yaxley, two-section, six-position, rotary switch indicates oscillator plate current, amplifier grid current and amplifier plate current. Each meter position has its own shunt so that a low range reading is possible for the grid current reading, a medium range for the oscillator plate current and a O-100 range for the amplifier plate current. Alternate switch points are used on the rotary switch so as to avoid the possibility of arcing when the switch is rotated. The use of individual shunts has a further advantage in that it makes all circuits complete when the meter is not in use.

Both power supplies, associated chokes and filters are mounted beneath the chassis. One power supply furnishes power for the speech amplifier and modulator and the other supplies power for the oscillator and amplifier. The use of two power supplies is almost necessary to provide the regulation for good class B operation. The high voltage for the amplifier is fed directly through the secondary of the output transformer, instead of through a choke-condenser arrangement. This method is satisfactory because the output transformer is well designed and the secondary is easily capable of passing the amplifier plate current. The secondary is designed to work into an 8000 ohm load. While this may seem somewhat higher than the usual

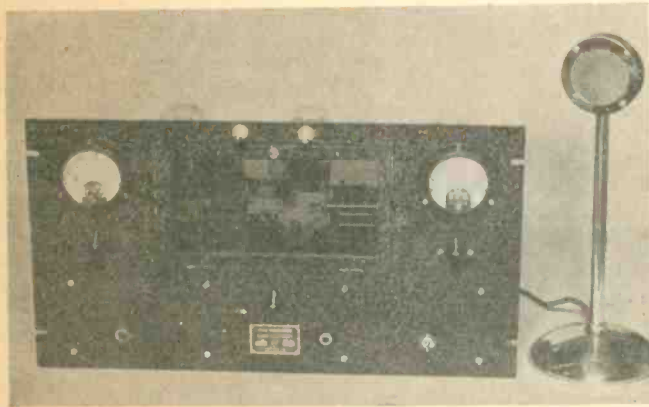

There are no tuning controls on the front panel of this 5-meter MOPA. All tuning adjustments are made by opening the small screen doors on the front panel. Symmetry gives way to efficiency.

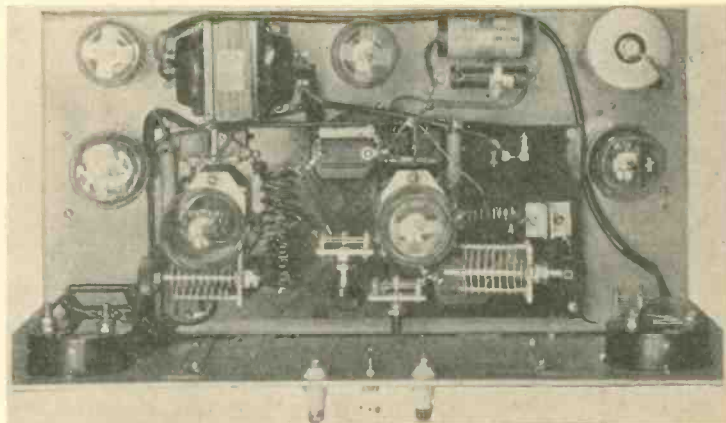

Looking down on the RF portion. The arrangement of the inductances L1 and L2 is plainly shown. The tuning condensers are wide-spaced Cardwell midgets. The R.F. tubes sockets (Isolantite) are raised well above the chassis.

is housed on a deck 6 inches high, 12 inches deep and 17 inches long. The front panel is standard, 10½ by 19 inches, relay rack size, since the unit is designed to fit into a standard relay rack with its associated receiver mounted on the lower panel of the rack. As the photograph shows, none of the main tuning controls come out to the panel; instead they are accessible through the screened door opening out from the panel. The importance of short direct leads can hardly be stressed too strongly. The leads are made shorter by not attempting to line up the various controls on the panel, and thus the added convenience in tuning is sacrificed for the sake of added efficiency.

Fig. 1 shows the complete circuit diagram. The oscillator is inductively coupled to the amplifier. A regular tuned circuit is used in the grid of the amplifier in order to provide a voltage step-up as well as to enable the use of series-grid-feed, which eliminates the necessity for an RF choke. Peculiarly enough, RF chokes are quite efficient at five meters and shunt feed is often used. The best choke is none too good, hence the use of series feed.

The amplifier stage is not unlike that used for any of the lower frequencies; the es-

formers are used, the 53 makes a good class B tube. As the circuit shows, one 53 is used as a push-pull, class B tube, and another 53 with both sets of elements in parallel is used for the driver tube. The crystal microphone was approximately 60DB down and it was found a stage of 56 was not enough to bring the level of the mike up to a satisfactory value. Consequently, a 57 high-gain amplifier was used. When a 57 is used, all circuits must be well by-passed and under no circumstances should less than 12 mikes be used in the cathode resistor bypass. If a smaller condenser is used, degeneration and subsequent loss of the low frequencies will result.

The O-100 milliammeter is connected permanently in the positive high voltage of the class B amplifier. This meter is helpful in determining correct setting of the gain control and assures the operator that the modulator and speech amplifier stages are working properly. An O-1 meter in conjunction with a Yaxley, two-section, six-position, rotary switch indicates oscillator plate current, amplifier grid current and amplifier plate current. Each meter position has its own shunt so that a low range reading is possible for the grid current reading, a medium range for

secondary load, it works out to best advantage since the class C amplifier presents this load with a plate voltage of 400 volts and a plate

current of 600 milliamperes.  $\frac{400}{.060} = 8000$

ohms, while  $400 \times .060 = 24$  watts, the correct input. There is nothing particularly sacred in exactly matching the class C load to the modulator since small amounts of mismatch change the modulator output but slightly.

This transmitter is completely AC operated; no battery is required for the microphone since this device generates its own voltage. A small amount of fixed bias is necessary as a safety measure for the amplifier stage and this bias was obtained by means of the automatic resistor method. The resistor in the center-tap circuit is arbitrarily adjusted with the plate current set to the working value by the antenna load, and the drop across it is then measured with a voltmeter. This resistance is so adjusted as to have approximately 25 volts drop across it. The voltage drop is then measured across the grid leak and the two bias voltages are added in order to obtain the effective bias on the tube. The values of these two resistors are



changed until the correct bias is obtained. The amount of drop across the cathode resistor should be kept to the smallest possible value so as to keep the plate current within safe limits, should the excitation fail. The bias for class C operation is determined with small error by the formula:

$$\frac{\mu}{\text{Plate voltage}} \times 2$$

On the final adjustment, the sum of the two biases should equal this amount. During the course of this adjustment it is well to bear in mind the fact that changes in the bias will likewise change the plate current and consequently the load resistance which the class C stage offers to the modulator. It is necessary to keep the plate current fairly constant during adjustment, by simply changing the antenna coupling.

In tuning the transmitter, the following procedure is used: First the oscillator should be set to the desired frequency by use of a frequency meter. The plate voltage on the final amplifier should be disconnected during the course of the pre-

liminary adjustment. The milliammeter is now switched over to read grid current, and the grid tank condenser is adjusted for maximum reading. The final amplifier condenser is then tuned to resonance, as indicated by a dip in the grid current. Bring the grid current back to an optimum value, which will still be below its former value, and then adjust the neutralizing condenser until the grid current remains constant when the final amplifier tank is tuned through resonance. Plate voltage should then be applied to the final and the milliammeter switched into the amplifier plate circuit. The plate current should then be tuned for a minimum reading, by adjusting the final tank condenser.

The quality of voice from this transmitter leaves little to be desired. It speaks for the advantages of the driven amplifier type of ultra-high frequency equipment.

This transmitter was designed by the writer in the laboratory of Western Wireless, Ltd., as a companion unit for the ultra-high frequency receiver described in this magazine three months ago.

## Dummy Antennas

When a transmitter is being tested, it is often desirable to utilize a dummy antenna instead of the radiating antenna in order to more accurately determine power outputs, as well as to prevent interference with other stations when the transmitter is being tested.

A dummy antenna usually consists of a resonant tank circuit whose condenser and coil are selected so as to resonate at the frequency at which the transmitter operates. This tank circuit is coupled to the transmitter either by direct coupling, capacitive coupling, or inductive coupling. Link coupling is the more desirable, because it affords a convenient means for varying the degree of coupling between the plate tank of the transmitter and the load tank of the antenna. In order to dissipate power, some resistance must be coupled into the dummy antenna load tank. A convenient method is one in which one or more electric lamp bulbs are connected in series and the bulbs then tapped across various turns of the tank coil until the final amplifier draws the proper plate input from its power supply.

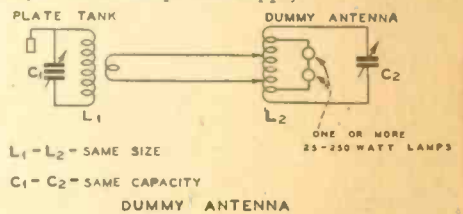

The resistance of electric lamp bulbs varies widely with the filament temperature of the lamps; therefore it is difficult to determine accurately the power output of the transmitter by means of the I<sup>2</sup>R Law, because R is a variable factor. An approximate estimate of power output can be made by determining the brilliancy of the lamp bulbs when working as a dummy antenna, as compared with the brilliancy of the same bulbs when connected to a source of 60 cycle voltage. This voltage and current for this given degree of brilliancy can be accurately measured at 60 cycles, but it cannot be accurately measured at radio frequencies. In other words, the power consumed in lighting the lamp to a given degree of brilliancy is the same whether the power is radio-frequency energy or power derived from the 110-volt, 60-cycle power line.

## BOOK REVIEW

### New 5-Meter Book

The second edition of Frank C. Jones' book, "Five Meter Radiotelephony," will be ready for distribution on December 20. The new edition has been completely revised and many of the latest 5-meter combination transmitters and receivers are described. There is also a chapter devoted to 3/4-meter operation. Circuits using the newer tubes are shown.

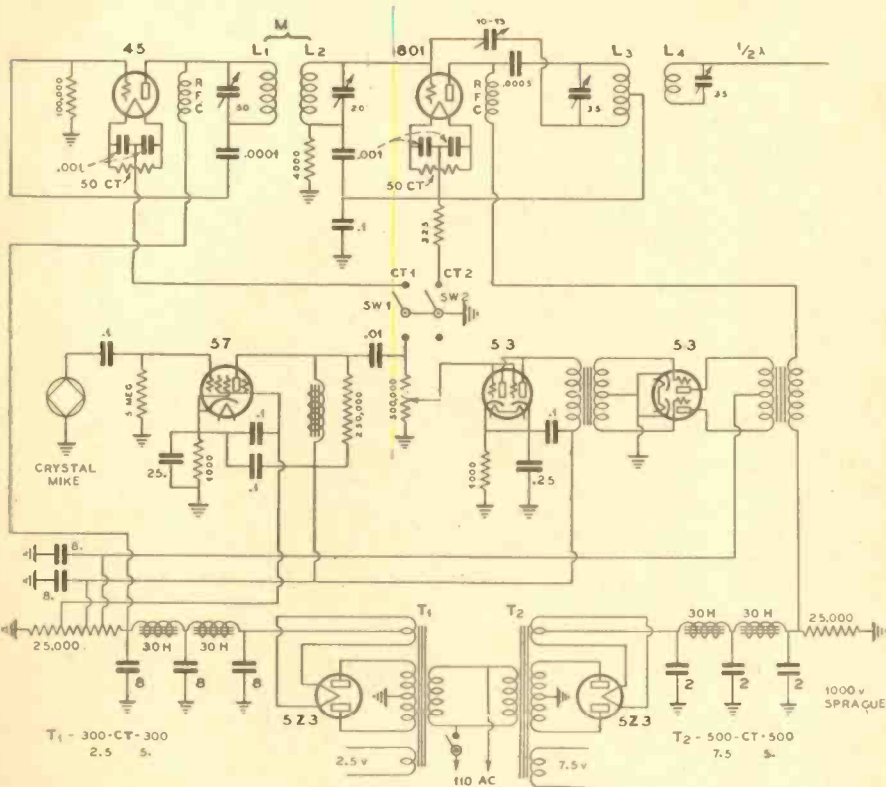

Complete RF, Speech and Power Supply Circuit Diagram of 5-Meter M-O-P-A.

Coil-Winding Data for 5-Meter Operation: L1—6 turns, No. 12 enameled wire, spaced one inch between turns and wound on a 1-inch diameter form. L2—4 turns, No. 12 enameled wire, self-supporting, air-spaced between turns, 1-inch diameter. This coil is placed 1 inch away from L1. L3, L4—6 turns, No. 12 enameled wire, spaced 1/8-inch between turns and wound on 1-inch diameter form.

# Hamdom's Cartoonville—By "PHILLIP SPACE" GILDERSLEEVE, W1CJD.



# Operating Notes on the Les-Tet 2B6 Exciter

By FRANK LESTER, W2AMJ\*

THE "Les-Tet" exciter unit using the 2B6 tube, as described in the November issue of "RADIO", has aroused a great deal of interest among amateurs all over the country. Hundreds of letters have been received requesting more "dope" on the tube, on the method of adjusting the circuit, and on coil specifications. In this article the writer will attempt to answer some of the numerous questions that have been asked.

The 2B6 tube itself seems to be something of a mystery to most amateurs. The fact that the inside of the envelope is nearly a solid black mass has given rise to all sorts of queries about the internal construction.

Please note that unlike the 53, with which the 2B6 is generally confused, the 2B6 consists of two altogether differently sized triodes. The first one, mounted directly above the glass stem, is very small, the plate measuring only 1/2 inch high and 3/8 inch wide. Directly above this assembly, on the same supports, is a much larger triode, the plate of which is about 1 1/4 inches high and 7/8 inch wide, with side flanges for heat dissipation. The cathode of the small triode is internally connected directly to the control grid of the large triode, giving direct and effective coupling between the two "tubes". The heater is rated at 2.5 volts, 2 1/4 amperes.

It has been found that nothing is gained by using more than 250 or 300 volts on the small plate for crystal operation, as shown in the "Les-Tet" circuit of Fig. 1. The maximum plate current of this section is 8 to 10 ma., even less with a good crystal.

In trying to ruin a 2B6 deliberately and at the same time find out what the tube can do, the writer ran the voltage on the large plate as high as 1150 volts, with the plate milliammeter reading 45 ma. There was no apparent sign of overheating; in fact, the tube was noticeably cooler in this circuit than when used in an audio frequency circuit for P.A. use with only 300 volts on it. During this test the oscillator plate voltage was maintained at 250 volts, while the output of the amplifier section was between 17 and 20 watts.

For the benefit of amateurs who make their own exciter units, the method of adjusting the entire circuit is given as follows.

## Straight Oscillator-Amplifier Operation

Neutralizing the second triode plate-to-grid capacity is done first. Turn on the filament and let it warm up for 30 to 60 seconds. It is advisable to use a trifle more than 2.5 volts rather than a little less.

Plug in the crystal and the upper L1 and L2 coils for the desired frequency band. (Coil data given later.) Apply 250 volts to P1 and 400 to 500 volts to P2. Make sure the key is UP. Adjust the cathode tank circuit L1-C1, by means of C1, to resonance with the crystal frequency. This condition is indicated by a pronounced dip of the plate milliammeter. Keep the amplifier tank condenser C2 at zero during this process. The out-of-resonance plate current of P1 is between 15 and 20 ma.; resonance current between 5 and 7 ma.

With the key still open, and the neutralizing condenser C3 at zero, tune the amplifier tank condenser C2. As this approaches resonance with the crystal frequency, the oscillator plate current will rise sharply and in some cases the oscillator is likely to stop oscillating because of the load on it.

With the key still up, turn in the neutralizing condenser C3 about half way and swing C2 slowly. If the oscillator plate current is still affected, continue to adjust C3 until the oscillator plate current remains fixed when C2 is varied throughout its entire range. The second triode is then properly neutralized.

The neutralizing condenser adjustment is likely to affect the tuning of the crystal oscillator cathode tank to a slight degree, because the neutralizing voltage is taken off

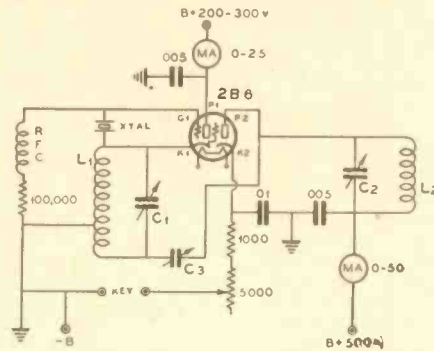

"LES-TET" 2B6 EXCITER

part of the L1 winding. Therefore, retune C1 a little for resonance with the crystal frequency before pressing the key and tuning the amplifier tank circuit to resonance.

As with other straight amplifiers, minimum P2 plate current indicates resonance with the oscillator driving frequency. The variable bias or excitation control R1 is left at maximum (6000 ohms in the cathode circuit), during this operation.

With maximum bias on the grid and 500 volts on Plate P2, the off-resonance plate current will be between 20 and 25 ma. and the resonance reading between 5 and 7 ma.

While these adjustments sound very complicated, they actually take less time to perform than it does to read the directions. If the crystal is a good one, and the coils properly wound, there is little probability of trouble.

## Oscillator-Doubler Operation

When the 2B6 in this "Les-Tet" circuit is to be used as an oscillator-doubler, neutralization is unnecessary. Coil L1 can therefore be a simple solenoid, without a tap. If the neutralizing condenser is set to zero, it will in no way affect the operation of the circuits on 160, 80 or 40 meters, even if a tapped coil is used. However, it has a slight effect on 20 meters, so the coil supplied commercially with the "Les-Tet" unit for the L1 position merely is the same as the tapped 40-meter coil but without the tap. If this

sounds confusing, let's take some specific examples of crystal and oscillator choices and see how they work out.

Without question, 95% of the amateurs interested in this exciter want to start on 80 meters and work also on 40. Others want the 40-20 meter combination. For 80 meters, an 80-meter crystal is used in the grid circuit of the small triode, and 80-meter coils used for both the L1 and L2 positions, so that all circuits are tuned to the fundamental crystal frequency and neutralization is necessary, as described.

For 40-meter operation, doubling with the same crystal, the 80-meter coil is left at L1, and a 40-meter coil used at L2. The large triode (K-2-G2-P2) thus amplifies only the second harmonic of the oscillations in the plate-cathode circuit of the oscillator triode, and no neutralizing is necessary. Merely make a notation of the C3 setting for 80-meter neutralization, and set the condenser back to zero for 40-meter doubling. The changeover can thus be made in a few seconds.

Greater output on 40 meters will, of course, be obtained if a 40-meter crystal is employed and the amplifier then used as a straight amplifier. For 20-meter work, frequency doubling must be resorted to, with a 40-meter crystal, as there are no commercial 20-meter crystals available. The same idea applies as an 80-40 doubling. An untapped 40-meter coil is used at L1, and a 20-meter coil at L2. The L2-C2 combination is tuned to 20 meters and therefore responds only to the second harmonic of the L1-C1 circuit, which is tuned to 40 meters.

Frequency tripling and quadrupling is also possible with the 2B6 "Les-Tet", but it is advisable for the amateur to get a little experience with straight amplifying and doubling before he attempts anything more advanced.

Although intended originally as an exciter unit for a 100-watt amplifier using two RK20's in push-pull, the 2B6 all by itself makes a fine transmitter. Energy can be taken off the amplifier tank coil L2 by conductive or inductive means, to feed an antenna in accordance with the standard principles of feeder design and antenna construction.

Tuned Zepp feeders can be used if another coil is coupled to L2, or single wire feed is possible merely by tapping on to it. The writer recommends the new Collins impedance matching system, which has been described at great length and needs no further explanation here.

With a conservative power input to the amplifier section of 15 watts, excellent DX can be expected. This outfit emits a strictly

(Continued on page 11)

## "LES-TET" COIL DATA

All forms 1 1/8 inches outside diameter.

	20 meters	40 meters	80 meters
L1	same as 40 m. coil, no tap.	15 turns, #18 DCC, spaced 1/16". Tap, 5 turns up from bottom.	24 turns, #18 DCC, close wound. Tap, 8 turns up from bottom.
L2	7 turns #18 DCC, 1/8" spacing. Link coil, 4 turns #22 DCC, close wound, 1/4" from cold end.	15 turns, #18 DCC, spaced 1/16". Link coil, same as for 20 m.	24 turns, #18 DCC, close wound. Link coil, same as for 20 m.

\* Engineer, Wholesale Radio Service Co., Inc., New York, N. Y.

# Five-Meter Filter Circuits

By FRANK C. JONES  
Ultra-Short Wave Editor

ONE of the major problems of 5 meter auto radio is a suitable plate voltage supply. B-batteries are cumbersome and expensive, if often replaced. A small B-eliminator or dynamotor, operating from the car 6-volt battery, is the solution to this problem. The eliminator or dynamotor occupies but little space and the device can be made to supply from 150 to 300 volts of DC voltage.

However, most amateurs who have tried these systems have experienced trouble from a hash of noise in either the transmitter or receiver, or both. Additional audio filter in +B leads seem to be of little help. The trouble is caused by RF disturbances which get into both the A and B leads to the 5 meter set.

RF disturbances can be confined to the dynamotor or vibrator eliminator itself by means of simple RF chokes. The circuit in Fig. A has worked satisfactorily when used in connection with various types dynamotors. The 8 mfd condenser acts as an audio filter and low impedance by-pass for the audio or modulator return circuits. The RF choke in the +B leads prevents RF from running up this lead to the set. All RF chokes should be mounted as close to the power supply unit as possible.

The RF chokes in the 6 volt leads must be made of heavy enough wire to carry the continuous load of this unit, which may be from 2 to 10 amperes, depending upon its rated power input and load. Usually No. 12 enameled wire, close wound on a 5/8-in. dowel rod for a length of about 2-in., will be suitable for these 6-volt lead chokes. The plate RF choke should have more turns of fine wire, such as No. 32 to No. 34 DSC on a 3/8-in. diameter rod, for about a 1-in. length. This number of turns in the larger chokes would make them unreasonably bulky, so an effective compromise is made to keep the size fairly small.

Occasionally a 1/2-mfd. condenser must be connected from the hot side of the battery at the dynamotor terminal to some particular spot on the dynamotor frame or housing.

The circuit shown in Fig. D has often been used to remove the hash from a 5 meter transmitter when using a dynamotor power supply, or to prevent the clicking noise from a vibrator supply unit. Sometimes these units will be quiet enough for use on a receiver of the super-regenerative type but they will

introduce noise in the transmitter due to lack of mike circuit filtering. A simple filter consists of a 20 to 50 mfd. 25-volt electrolytic condenser to complete the voice frequency circuit, and a 100 to 200 ohm 1-watt resistor in the hot side of the 6-volt supply. Care must be taken to see that the polarity of the electrolytic condenser is correct; its negative side is toward the negative 6-volt supply, and the positive terminal toward the positive 6-volt supply lead. Either the negative or positive terminal of car batteries are grounded to the car frame, thus it is always necessary to first check the polarity.

The circuits of Fig. B and Fig. C are useful in preventing noise from getting into either the transmitter or receiver. The resistor-type filter cannot be used here, since the current drain through it would be too great. A low resistance choke of from 0.1 to 1/2 henry inductance, and small fraction of an ohm of resistance, is somewhat a problem, but it can be solved. Some small dynamotors are equipped with such a choke, but usually without the 50 mfd. condenser or RF chokes. If no audio filter is furnished with the dynamotor, at least an 8 mfd. electrolytic condenser must be connected across the plate supply, either in the 5 meter set or at the power supply terminals.

Fig. B and Fig. C are somewhat similar and are given in order to show the change of connections necessary when the car battery is grounded to -6 in one case, and +6 in the other.

These RF filters should be mounted close to the dynamotor or eliminator in order to be effective. Ample space can be found inside the dynamotor container for these RF chokes. If not, the chokes should be mounted rigidly in a metal can adjacent to the unit. Needless to say, the 6-volt supply to the 5 meter set should come from the battery side of the RF filters.

It is always good practice to run the power leads directly to the car battery in order to avoid car ignition noises. The usual resistor-type spark plug and distributor suppressors will kill 5 meter interference. The conventional by-pass condenser at the car generator is advisable. Fortunately, the car ignition system noise is easily minimized, but the broadcast type RF choke type suppressors will not work on 5 meters. These suppressors are usually layer-wound and they are useless at high frequencies.

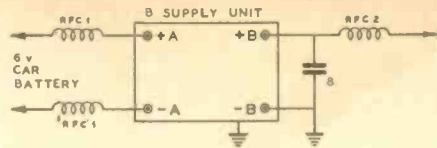

FIG. A

RFC1—25 turns No. 12 wire on 1/2 to 5/8 inch dia. form.  
RFC2—75 turns No. 32 to 34 DSC wire on 1/4 inch dia. dowel or bakelite rod.  
Either positive-A or negative-A battery terminal of car can be grounded.

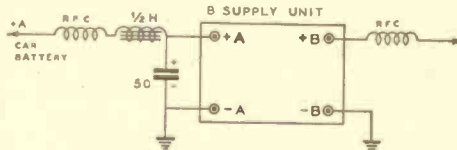

FIG. B

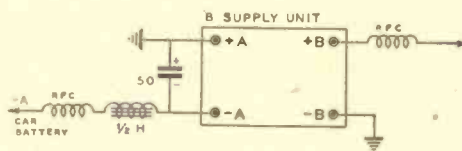

FIG. C

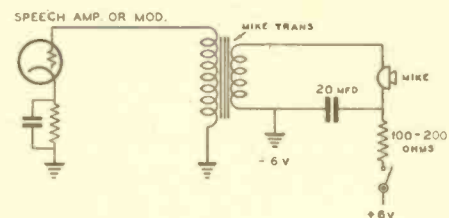

FIG. D

## Les-Tet Exciter

(Continued from page 10)

1934 signal—clear, steady and piercing—and more than complies with all Federal Communications Commission requirements.

An amusing incident concerning the "Les-Tet" was related to the writer by W2EXM, a well known New York amateur, shortly after the first article appeared in "RADIO". W2EXM's 50-watt three-stage transmitter developed power pack trouble and had to go off the air. As EXM had some schedules to keep, he bought a 2B6 and hurriedly threw together a duplicate of the outfit shown in the diagram. A few local hams, when asked for a report, remarked casually that the signals sounded a little weaker than usual, and they absolutely refused to believe EXM when he told them he was using the 2B6 and nothing else. As a result of his experience, there has been an epidemic of "Les-Tet's" around the Bronx, with uniformly good results being obtained.

## Are You In Favor of a Silent Hour?

**DX** IS AN amateur's first and most passionate love, perhaps because it is so hard to get in these days when the ether lanes are more crowded than a busy highway during a week-end holiday. Much of his experimenting with new circuits and parts in an endeavor to get the most out of the least equipment, is in hopes for better DX. Meanwhile QRM stifles the most efficient equipment.

So it has been recently suggested that American amateurs refrain from transmitting on 40 meters for one hour during each month in order that everyone may have a chance to listen to foreign stations, which have agreed to transmit to American amateurs during this silent hour. They, in turn, would observe a similar silent period while American amateurs are transmitting to them. Monthly lists of calls heard could be published so that all may know how well they are reaching out. Suitable awards might also be given those

who report the greatest number of stations heard.

If the plan be approved by a majority, we feel sure that the disapproving minority would be good enough sportsmen to cooperate enthusiastically, exhibiting the same helpful spirit that has been shown by Republicans in supporting the policies of President Roosevelt. Anybody who says that they will not get together with the majority is slandering them. Which brings to mind the story of the visitor to the insane asylum who asked the keeper if he was not afraid that the inmates would get together and overpower him. His retort was "They can't get together. That's why they are here."

Anyway, what do you and your friends think of the idea? Write and tell us whether they and you are willing to listen instead of to send for one hour a month, said hour being at night so as to give the best results on 40 meters.

# How a Y. L. Police Reporter Works

## The Story of W9DXX—Mrs. Alice R. Bourke

MRS. ALICE R. BOURKE, hamishly known as W9DXX, for years past has been connected with the Chicago newspaper world.

For eight years she lead an interesting and exciting existence as police reporter for the Chicago Tribune, and is probably the only woman journalist ever assigned by a great daily to cover crime as a regular night assignment.

Mrs. Bourke's "beat" for the Tribune covered more than a third of Chicago, including the "black belt", the stamping grounds of the war-lords of Beerland, the University district, the steel mills, and the finest residential section of Chicago. It ran from placid Lake Michigan on the east, to Bloody Cicero, the Capone stronghold, which forms the western boundary of the city.

Twelve police stations located in Mrs. Bourke's district furnished some of the biggest news stories that have broken in recent years.

Mrs. Bourke's work on the Loeb-Leopold story was rewarded by a FB bonus check presented by the Tribune.

Police reporters comprise the shock troops of journalism. They are the unsung heroes of newspaperdom. Their names rarely get into print—except when they make the obituary column. They get all the drudgery and hard work, the long early-morning sub-zero chases out to where "X marks the spot", they never get any sleep, BUT—if they prove trustworthy, they get ALL the news-tips, and ALL the fun and exhilarating thrills!

Fortunately for Mrs. Bourke's newspaper career, she gained the reputation of keeping faith and respecting confidences. A cop or gangster could give her the "low-down" on a story, secure in the knowledge that the source of the news would not be divulged. Consequently, most of W9DXX's stories were exclusive.

For the first month after Mrs. Bourke's assignment to the south side night police beat, the presence of a YL reporter was a matter of surprised embarrassment to the desk sergeants and squads. Then the ice thawed and they forgot she was a YL.

W9DXX knows several thousand Chicago cops. She was first to hear about their engagements, what the new baby was to be christened, and how long it was after Junior's tonsils were taken out before he could swallow! She cannot speak too highly of these policemen for their unflinching courtesy, their kindly helpfulness, their tact, and priceless, concerted determination to see that she got the news first!

The past ten years might be called the "Colorful Era of Chicago Crime". Never again will that city countenance another notorious character of such headline-magnitude as Alphonse Capone. Prohibition repeal and police radio legislate against it!

But Public Enemy No. 1 and all the lesser enemies have furnished plenty of thrills for W9DXX. During the past decade she has known and interviewed the "Bad Wolves" of Chicago gangland, and, sad to relate, she has found a few of them to be rather likeable chaps, in spite of their lurid reputations!

Fortunately for Chicago, most of these men are gone, some to prison, the wisest to permanent hideaways, but most of them by the sawed-off shotgun route.

The ability to make friendships is the greatest asset a reporter can have.

On one occasion there was a shooting involving two bandits and two policemen. The

bandits escaped, to be captured a few hours later. One police officer was killed, his partner was shot. Only the injured cop knew, or could tell what had happened. Before he was taken for surgical attention, he had a fellow-officer tip-off Mrs. Bourke where he could be found. Result: one exclusive first page story with 8-column heading, and seven exclusive pictures.

Another exclusive story came from a pull-motor squad which worked over a dying baby for 13 hours. The squad locked the doors,

The first time that W4DXX saw Margaret, the girl had been arrested as the queen of a smuggling ring. She was handsome, dark-eyed, and photographed beautifully. The police who arrested her tipped off Mrs. Bourke, and the Tribune got a 2-col. exclusive first page Sunday yarn. Margaret liked the story, and she liked the reporter.

The girl got out of that jam, and into many more during the next few years. Each time she was arrested, she would reiterate doggedly: "Send for Mrs. Bourke. I won't



Mrs. W9DXX and Her Modern Amateur Receiving Equipment

refused to talk to the newspapers, or answer any phone calls except those from W9DXX!

Still another exclusive first page 8-col. headline came about from a friendly old police captain who called W9DXX into his office late one Saturday night. "I don't know what it means, Mrs. Bourke," he said, "but I thought I'd tell you there are a great many outside squads out south tonight. Don't know why, but thought you'd like to know."

W9DXX called her office; the City Desk knew no reason for the influx of squads, and she was advised that she could go home early as things seemed dead.

On the way home, W9DXX saw a strange police squad whizzing along, and on a hunch decided to follow it. Three hours of work, many miles of speeding, much questioning, prying and piecing together, and she had a whale of a story telling of the rounding up of a gang of 16 men for robbing a Grand Trunk mail train of \$133,000 at Evergreen Park the day before.

All on the blind tip of a helpful old friend! The fact that the opposition newspaper took its kick on the "scooping" direct to the mayor and the chief of police made the joy of W9DXX complete!

Sometimes the confidence which Mrs. Bourke inspired was more annoying than satisfying, however, as in the case of Margaret Blank.

talk until she is here." And she wouldn't!

As Margaret specialized on being arrested about 4 a.m., W9DXX would just about get beneath the covers when some exasperated squad-leader, generally at the opposite side of the city, would phone, pleading: "Be a good sport and come over and get her to talk. We can't get a chirp out of her. Besides, it's a GOOD story!"

Of course, that always did the trick! The last time W9DXX saw the girl, she was in a Yellow Cab stand, where Margaret had gone to phone the police, claiming that she had killed a man. She was dressed in men's clothing, and had a gun in each hand.

The man she shot was a dope peddler. He did not die. Since then, her name has not appeared on local police blotters.

The most common question W9DXX encountered in connection with her police reporting was: "Aren't you afraid to go around on stories alone at night?"

The answer invariably was "No", because there never was any reason for fear. As a rule, there always were plenty of police around.

On only a few occasions during her years of newspaper work does W9DXX remember risking personal danger.

She barely escaped pneumonia when her feet froze solid to the pavement at a January early morning fire. Police begged her to

stay out of the black belt during the last race riots, but the Tribune said "Stay there." Although she was the only white woman on the streets within several miles, not a single person made a move to molest her, though she covered most of the street fights.

During a period when the leaders of two rival beer mobs had threatened to "kill each other on sight", and police were hot on the trail of both of them, W9DXX rode an hour through the "Bad Lands" in an auto containing one of the two warring Big Shots and his

ed under the firepit, the engineer dropped a great load of steaming ashes and red-hot coals to the track. If he had done so a fraction of a minute sooner, W9DXX would not be indulging in amateur radio today.

The first public appearance of W9DXX's new outfit was also the last!

The introduction of radio brought a great change to the police department, and to police reporting.

Up to 1929, a scoop could be "kept on ice" so long as the policemen and the reporter

had to fight its way through. Just a false alarm!

Two weeks later a man was murdered in a hotel in the Oakland district. When W9DXX arrived with the squad, it was necessary for the officers to draw their revolvers to get through the jam of 3,000 sensation seekers outside the hotel.

The "old-timers" among police reporters remember the leisurely days before the automobile speeded up the tempo of the news. The contemporary police reporters found their activities augmented dizzily by the advent of radio.

Radio was not new, however, to Mrs. Bourke. Away back in 1922 she had been the proud owner of a Reinartz receiver which brought in a few market reports, a little music, mostly from KDKA, and plenty of mysterious, intriguing dots and dashes.

In those dim, departed days, receivers were still called "wireless sets", and people hesitated over the new word "radio", not sure whether ra-dio, or Al Smith's pronunciation was correct.

The Reinartz was responsible for Mrs. Bourke learning to read code, and her fanciful experiences with the old receiver were incorporated in a humorous story, "O Woe! Radio", which she sold to Radio Broadcast.

In 1930 Mrs. Bourke became W9DXX, but did not go in for consistent operation of her ham station until about a year ago, after her resignation from the Tribune, due to illness in her family.

The transmitter in her shack is crystal controlled, using a 47 oscillator, 801 doubler, 203A buffer, and a pair of 203As, push-pull in the final, with input of 450 watts on 40. The station is operated on 7040, 7160 and 14,320 KC. The receivers are a National AGSX, a Hammarlund Crystal Comet Pro, and a General Electric All-Wave.

DX includes all W, all VE, LU, NY, CM, X, K4, K6, TI, EA, ZL, VK, G and D. Signals have been heard in Poland and Russia.

W9DXX handles traffic, and enjoys rag-chewing and DX-fishing. She is a member of the A.R.R.L., I.D.A., Réseau Belge, Réseau Française, R.S.G.B., and has the honor of being the only YL member of the Society of Wireless Pioneers.

In addition to her newspaper work for the Chicago Tribune, W9DXX has been editor of the Chicago Comet, a south side community newspaper, and for a time was a member of the editorial staff of the Chicago Daily News. She has contributed fiction and articles to the national magazines, and has edited several books. She has two hobbies—amateur radio and book collecting, and owns a large library containing more than 3,000 first editions, and many inscribed and association copies.

•••

## Book Reviews

*Applied Acoustics*, by Harry F. Olsen and Frank Massa (RCA Victor Co.). Published by P. Blakiston's Sons & Co., Inc., Philadelphia, Pa. 430 pages. Price \$4.50.

A thoroughly modern treatise on the subject of electrical and electro-acoustical systems. A first-class treatise on the subject, one which fills a long-felt need. The information should be of great assistance to the engineer interested in sound work, as well as those wishing a complete and concise theoretical and practical exposition of loudspeakers, microphones, telephone receivers, architectural acoustics, and associated apparatus and equipment.

Complete enough to be used both as a text and as a standard reference work. The authors presuppose a reasonable knowledge of physics, mathematics and electrical theory, and while not recommended for beginners, the work is a symposium of ten years original acoustical research and development by the authors. At the same time it is a concise and coherent inclusion of the allied developments of other engineers and scientists. As such it is a very complete and satisfactory work.

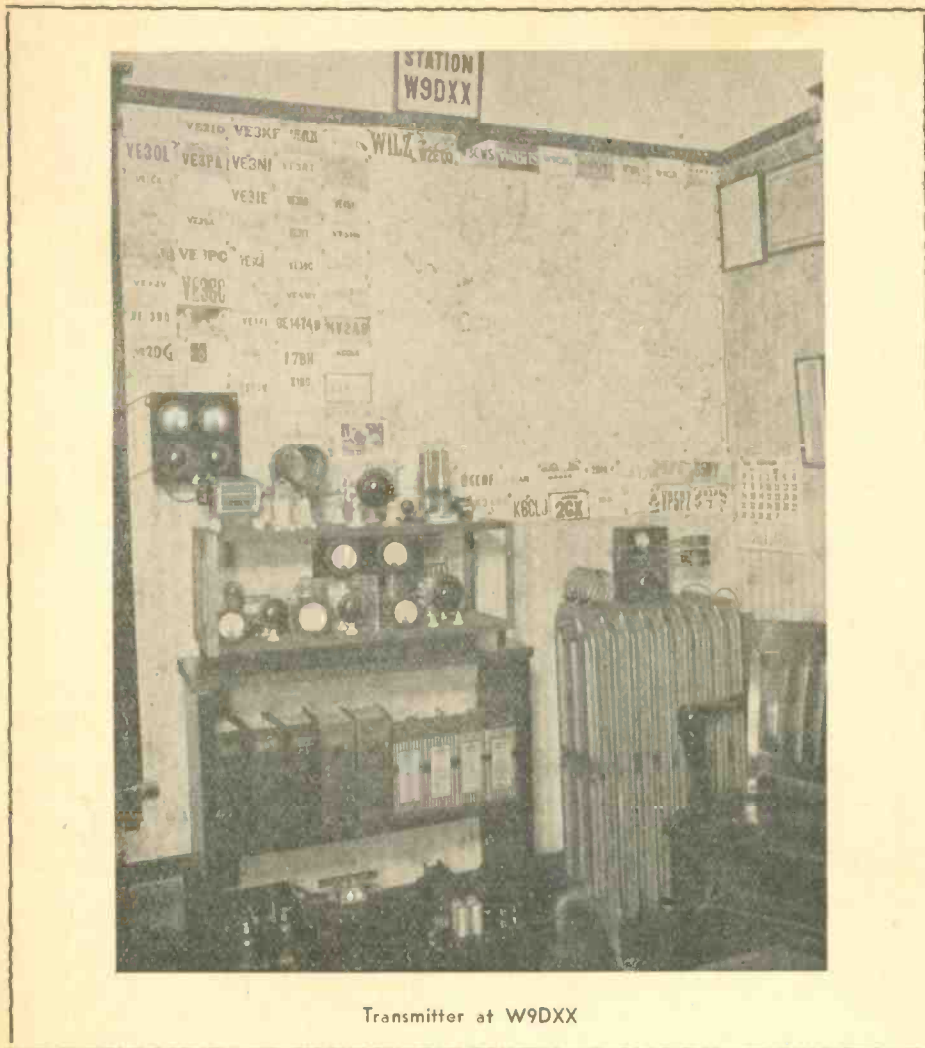

Transmitter at W9DXX

four body-guards. The story W9DXX got was a good one, but she admits a creepy sensation in retrospect!

An undignified flopping down to the floor of her car was W9DXX' prompt reaction to driving into cross-fire during the "smoking out" of a colored murderer hiding in an unfinished court building, early one spring morning.

On one of W9DXX's "nights off"—which really do not mean much in newspaper parlance, she and the OM were ready to leave the shack for the theatre, when the phone rang. It was the City Desk.

"Listen, Lady, there's a big train wreck. We know it's your night off, but won't you please . . ."

W9DXX had on a new white silk dress, new white shoes and a new white hat. Fifteen minutes later, still so attired, she was climbing up a cindery railroad embankment on hands and knees. At the top, she discovered that she was on the wrong side of the track to cover the wreck. A travelling railroad crane blocked her path, and the only way to get to the other side was to crawl under the crane, which she did. Just as she clear-

working on the case could trust each other. If ten men of an auto-theft ring were in custody, and two others were sought, the reporter could hold the story up long enough for the police to nab the missing pair, provided he knew the police would give him the story exclusively.

With the coming of radio, such cooperation was at an end. Every clue was public property, and all the smart crooks had radios!

In 1929, the Chicago Tribune began broadcasting police calls experimentally over its station, WGN, and when Lieut. John Treacy's squad captured four men and women 3 minutes after they had stuck up an oil station, the newspaper story was generally commented on. We were living in such wonderful times!

Then the Chicago public went crazy over police radio, and so did distracted policemen and police reporters! The first week of the WGN police flashes, W9DXX and a squad responded to the call: "Man shot in prairie", half a mile away from the South Chicago police station. When they arrived three minutes later, a thousand other radio listeners were on the spot, and the squad

# One Pushee, One Pullee, Work Like Hellee!

THE first tube of an ever-increasing group in which Tantalum is used for grid and plate material, in order to obtain a high enough vacuum in which a thoriated filament will operate effectively, was the HK-354 Gammatron. When first introduced, this tube was regarded with a great deal of skepticism by the vast majority of amateurs, due to its many radical features. After a year of widespread use in amateur and commercial stations all over the world, it has been demonstrated that every claim originally made for the tube has been found to be conservative.



H-K354  
WITH  
LARGE  
ENVELOPE

Some recent minor changes in the HK-354 are worthy of mention because they make for increased ruggedness and longer life. The redesigned HK-354 Gammatron has approximately the same characteristics as the original 354 and is interchangeable with it. However, it should not be used in a push-pull circuit amplifier stage in company with one of the earlier types. Minor mechanical changes in the grid and filament structure, which cause

but a slight change in characteristics, are of sufficient importance to recommend the use of two similar tubes in order to obtain a perfect match.

The Nonex glass envelope of the new HK-354 has been enlarged in size to slightly less than 3 inches in diameter. This affords more heat-radiating ability and thus allows the bombarding process to be carried further than when a small size envelope is used. The plate supports have been modified so as to allow a longer heat conduction path between the plate and the point at which the three plate supports are beaded into the glass envelope. This new form of construction permits the beads to operate at a lower temperature and minimizes the possibility of failure at this point.

The grid structure has been

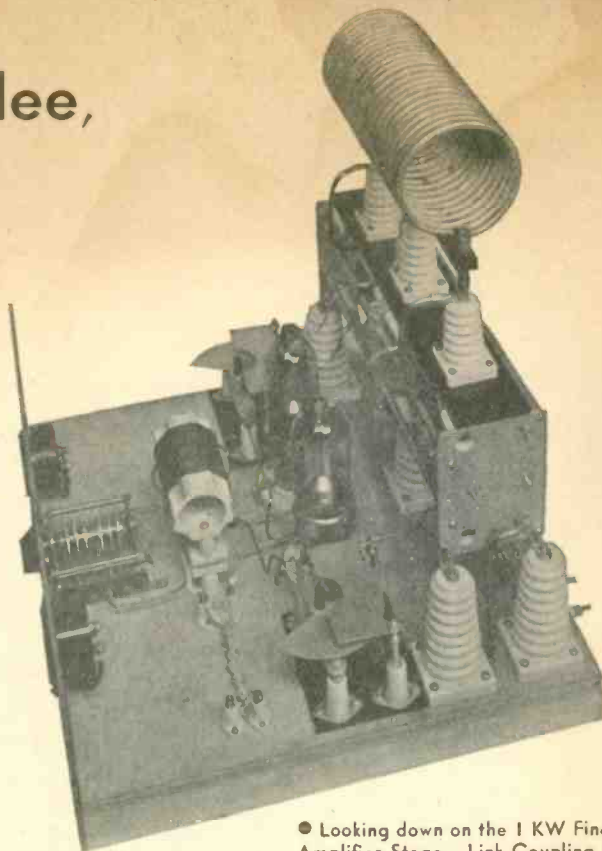

● Looking down on the 1 KW Final Amplifier Stage. Link Coupling is used to carry the excitation to the grids of the HK-354s. The Plate Condenser and Coil and unusually-well insulated.

used to carry the excitation to the grids of the HK-354s. The Plate Condenser and Coil and unusually-well insulated.

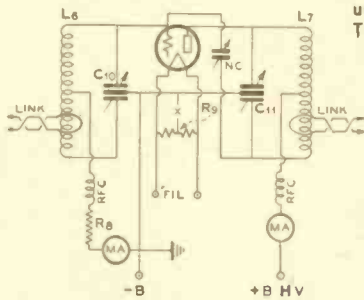

SINGLE HK-354 DRIVER  
FOR FINAL AMPLIFIER

RFC—Plate Choke, 500 MR., Heavy Duty. RFC  
—Grid Choke, 125 MA. Receiving Type H.F.  
R9—100 ohm C.T., 10 watts. R8—10,000 ohms,  
25 watt.  
C10—Split-Stator, 35 MMF. each section. C11  
—Split-Stator, 100 MMF. each section, 7500  
volts. NC—10 MMF. for HK-354 Tube, or 25  
MMF. for 211, 203-A or 830B.

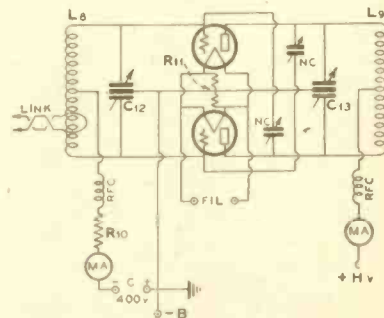

PUSH-PULL FINAL AMPLIFIER

RFC (grid)—125 MA. Receiving Type, HF.  
RFC (plate)—500 MA. Heavy Duty Xmtg. Type.  
R10—10,000 ohms, 50 watt.  
R11—100 ohms, CT, 10 watt.  
C12—Split-Stator, 35 MMF. each section.  
C13—Split-Stator, 100 MMF. each section.  
NC—2 Aluminum Plates, each approx. 3 inches  
square, spaced 3/4 inch apart.

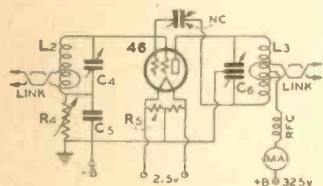

BUFFER-DOUBLE

RFC—125 MA. Receiving Type H.F. Choke.  
C4—Grid Condenser, 100 MMF. Single Section.  
C5—Grid-Blocking Condenser, .006 or larger,  
Mica. C6—Plate Tuning Condenser, Split-Stator,  
125 MMF. per section. NC—25 MMF. Midget.  
R4—Variable Grid Leak, 5000 ohms. R5—C.T.  
Resistor, 50 ohms, 2 watts.

## Driver for Final Amplifier

This unit drives the push-pull stage pictured in the upper illustration. A single new-type HK-354 is used. The Link-Coupling arrangement to the grid coil is clearly shown.

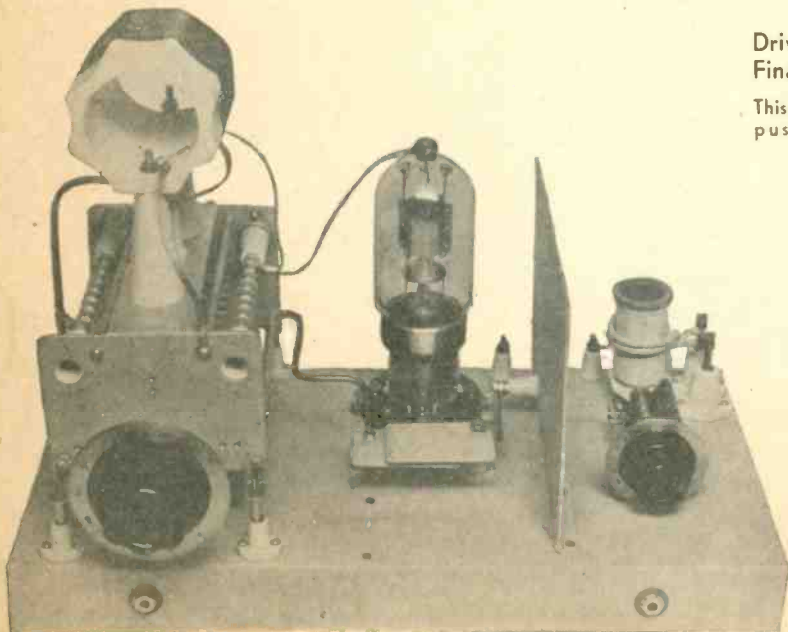

strengthened mechanically by the addition of a spiral reinforcing bar which extends the full length of the grid and which add considerably to its rigidity.

The new HK-354 is rated at 150 watts plate dissipation. The filament voltage is 5 volts at 7.75 amperes, exactly the same as in the earlier model; likewise, the amplification factor of 12 remains the same. The normal maximum plate voltage is 3,000 volts and the maximum plate current is 175 milliamperes. The plate lead is brought out at the top of the envelope and the grid lead is brought out to one of the base pins, as in the earlier models. The overall height has been increased to 8 1/4 inches.

Tantalum, as a grid and plate material, is here to stay because it seems to be the only material that permits the tube to be operated at momentary overloads without the release of gas molecules which poison all thoriated filaments.

(Continued on page 20)

# Look to Uncle Sam for Protection of Amateur Radio

By the POLITICAL EDITOR

**A**NOTHER Pacific Division Convention has come and gone. On November 10 and 11 the amateurs of Fresno, California, were hosts to approximately 536 of their fellow amateurs. Those who attended the convention were asked to write Yes or No to the question: "Are You a Member of the ARRL" in the official convention registration book. Of the 536 who registered, 155 stated they were members of the League.

A strange gathering! The unorganized amateurs were tremendously in the majority! Who would control the political meeting—the 155 League members, or the unorganized group of 381? The Director of the Pacific Division, S. G. Culver, one of the best-liked radio amateurs in the west, literally found himself between the devil and the deep, blue sea. On one side were the League members, the minority group . . . on the other side were the individuals of the majority group, clamoring for recognition. Representatives of the majority group asked for an equal vote.

According to Hoyle, this was a League convention. The situation was tense. Director Culver was no less concerned about the matter than the official representative of the League who was sent west from Hartford.

The political meeting was called to order. In a few words, Director Culver told the conventioners that an equal vote was to be had by all—League members and non-League members alike. An official document in the hands of the Director contained the news which brought a cheer from the audience. With equal voting privileges given all amateurs of the Pacific Division, it seems reasonable to assume that other amateur conventions can be conducted in like manner.

## The Resolutions Are Made

● Number One: The Convention adopted a resolution requesting Director Culver to secure from League offices, within 60 days, a report showing how many U. S. licensed amateurs are members of the League.

The names and addresses of League members are on addressing-machine stencils; 20,000 stencils can be run through the machines in a few hours—the recipients of the double post cards can be asked to indicate with a Yes or a No if they are U. S. licensed radio amateurs. Within 60 days most of these cards will probably have been returned to League offices. The percentage of those who do not mail back the reply card, because of negligence, because they are not sufficiently interested in the results of the poll, or for other reasons, should not materially alter the result.

The League is 20 years old. But not until this year has an official convention request been made to disclose this membership information which is still being withheld from the amateur.

The betting odds in western amateur circles are 100-to-1 (with no takers) that Warner will not divulge the information within 60 days, as requested by the conventioners.

## The Next Resolution

● Then came a resolution from the convention floor asking that WAC (Worked All Continents) certificates be issued without cost to amateurs who have reached the sacred goal. No longer would it be necessary for an amateur to be forced to pay \$2.50 for a combined magazine subscription and League membership in order to decorate the wall of his ham shack with a WAC certificate. The resolution was presented by one of the progressive amateur warriors from San Jose. For in the San Jose club is a leader whose name is Colonel Foster, W6HM . . . and it

was the Colonel who first conceived the plan of awarding an honor degree to any amateur who succeeded in spanning the globe with his signals. The Colonel's original plan called for no other restrictions. Yet a much-surprised and disappointed applicant for a WAC certificate had complained that he could not receive his parchment because he did not pay the required sum of \$2.50 for a League membership. "Rich and poor alike should share in the glory of the WAC award," shouted a spectator in the audience. But the League's representative at the convention stated that it costs money to print WAC certificates, costs money to mail them . . . that there is a lot of office detail connected with the issuance of the certificates. Whereupon it was moved, seconded and carried that League members be given WAC certificates without cost, and that non-members be asked to pay fifty cents to cover a portion of the cost of issuing these certificates. If the resolution finally wins the approval of the board, it will cost the "outsider" only 20 per cent of what he must now pay to show printed proof that he, too, is a member of the honor brigade. Perhaps in later years, when the League treasury contain more than the \$60,000 it now holds, a 2 per cent WAC discount may be given for cash.

## Continuing With the Resolutions

● Then came the spokesman from the Federated Radio Clubs of Southern California, who moved that a resolution be adopted to instruct the Pacific Director to request a split-up of the State of California so that the south could have a director of its own. The city of Los Angeles is more than 400 miles south of San Francisco, the distance between the two cities too great for a single director to adequately cover. True! But a remark by the gentleman from Los Angeles . . . that the political beliefs of amateurs in the south do not coincide with those of the north . . . is not true. The southern amateurs are just as progressive as their brother amateurs in the north, perhaps even more so, if the editor's mailbag is a criterion of the political beliefs of the respective groups. The amateur must fight for his privileges, no matter whether he lives in Los Angeles or in Lexington.

## Now the Bombshell

● The publisher of this magazine asked for, and received the floor. His statement that the future of amateur radio lies in the hands of the Government of the United States—that in order to safeguard our privileges, or to acquire additional privileges it will first be necessary for the amateur to secure the 100 per cent backing of his own Government . . . that the amateur must present his case to all Senators and Representatives . . . that Congress instruct our State Department to secure added privileges for the amateur, was met with a partial rebuke by the League's representative. Believing that the League representative was selling short the Government of the United States, no further attempt was made to present the program which the publisher of this magazine had in mind. But it is here presented for your approval. The plan was conceived jointly by Colonel Foster and by the publisher of "RADIO." Every progressive reader of this magazine is urged to do his part in order to assure the success of the plan.

Let us begin by first reminding you that you live in the United States of America. You are licensed by the Government of the United States. You are FIRST a citizen of the

United States, and NEXT a U. S. licensed amateur. The government has the power to license you, to revoke your license; it also has the power to protect your privileges, or to secure added privileges for you. You, as a citizen, as an amateur licensed by your own Government, have the privilege of requesting the cooperation of Senators and Representatives whom you elect to office.

There are few men in Congress who know that a radio "ham" is not of the same specie as the product manufactured in the plants of Swift, or Armour & Co.

How, then, can we expect our Congressmen to do anything for us when many of these men do not even know who we are?

First get a pledge from every man in Congress to protect our amateur privileges. Get the pledge in writing!

When the American Delegation to an International Convention is chosen by the President of the United States, ask your Congressman to persuade our President to appoint a few radio-amateur-minded men, so that we, as amateurs, will have better representation at the next Conference. The State Department instructs the American delegation to the Conference as to what it is expected to do. Ask Congress to cooperate with the State Department . . . to make certain that we do not go to Cairo empty-handed!

If you have the assurance of Congressmen that amateur interests will be protected, and if the Delegation to Cairo does not respect your wishes, fall back on the Congressmen from whom you received your pledges and ask these men to solicit the aid of the State Department so that the Delegation can be notified to protect the interests of the amateur. Once a Congressman gives you a pledge, you need not fear that he will betray you.

Let every radio club in the nation do its part. Bring pressure to bear on your Congressmen . . . now . . . just as the leaders of the Amateur Radio Protective Association are already doing.

A vigorous attempt is to be made at the Cairo Conference to take the present 160-meter band away from the amateurs. Our prized 40-meter band is the goal of other interests. One of the more-important commercial radio executives recently said to this writer—"the amateur will eventually find his resting place in the five-meter band, unless he is aggressive enough to fight for the privileges he now enjoys."

The cry of this magazine has been for aggressive leadership! Look to Congress for leadership . . . to pull us out of the sea of difficulty. Congress can help us get some amateur-minded men on the Delegation to Cairo. And, while we are at it, why not ask President Roosevelt to put a couple of good amateurs on the FCC, if only in an advisory capacity—without any cost whatsoever to the Government? We know of many good men who are anxious to serve!

## A. S. MacKenzie . . . . . 30

**I**T IS our painful duty to record the passing of one of commercial radio's oldest and best-liked operators. Addison S MacKenzie, for many years owner-instructor of Pacific Radio School in San Francisco, signed off on November 8. His death came suddenly. On the morning of the day of his passing he was in excellent health. Some repair work was being done to the antennas atop the building in which the school is located. MacKenzie completed the job, returned to the classroom, relaxed in his chair and passed away.

His death came as a distinct shock to all who knew him. Many of commercial radio's operators on shipboard and at shore stations were given a helping hand by MacKenzie, not only in the form of free tuition for those who could ill-afford the fee, but also in the form of subsistence for those whose circumstances were such that even the cost of bread and butter was beyond their means.

# Design Factors for Class-A Prime Amplifiers

By I. A. MITCHELL\*

UNLIKE Class A amplifications, in Class A prime (AB) and Class B, the characteristics of plate load, driver power, input transformer, plate and bias regulation are all interrelated. For proper operation, it is essential that all of these factors be fully considered. Properly designed, an audio amplifier using either Class A prime or Class B amplification will permit a much higher output from a given pair of output tubes than a Class A amplifier using the same tubes, and with considerable increase in plate efficiency.

In a Class A amplifier, the bias voltage is normally chosen approximately midway between zero bias and the bias required for plate current cut off, so that the grid voltage is permitted to swing the plate current over the linear portion of the tube characteristic. This normally results in a condition such that the DC plate current does not change appreciably when full signal voltage is applied to the grid, and the plate current is not cut off during any portion of the cycle. For undistorted output from a single output tube, these conditions must be met fully. If the tube is operated above the substantially linear portion of its characteristic, considerable distortion will be present in the output.

However, when two tubes are operated in push pull, the nonlinear sections are made to complement each other and thus effect a comparatively linear overall characteristic. In a perfectly balanced push pull circuit this results in the complete elimination of 2nd harmonics. Inasmuch as the grid is never driven into the positive region in Class A amplification, the grid current is negligible and the input grid impedance practically infinite.

In normal Class B operation, the tube is biased almost to cut off. Consequently, as the signal voltage is increased, the average plate current increases. The fact that the tubes operate over a much greater portion of the characteristic makes it possible to obtain greater power and efficiency than from a similar Class A setup. In Class A prime, the bias is adjusted between the Class A and Class B values. The normal plate current with no signal lies between the Class A and Class B values and the plate current is substantially constant for low applied signal. However, as the signal is increased, the plate swings over a larger portion of the characteristic, similar to Class B, and the average plate current rises. The high bias applied to the tube in A prime operation allows a large swing in applied signal before the grid is driven positive. In other words, at low and medium levels, a Class A prime amplifier is substantially an ordinary Class A amplifier somewhat overbiased. No grid power is required and the grid impedance is high. For maximum power, however, the grid is driven positive.

The action of a vacuum tube amplifier is such that the instantaneous grid voltage affects a corresponding voltage in the plate circuit which is in turn coupled to the output load. It is apparent that for undistorted output from the plate circuit, the grid voltage must not be distorted. In a Class A circuit, where the grid impedance is uniformly high, this condition is easily met. In Class A prime or Class B, considerable care must be taken to meet this condition.

Fig. 1, the characteristics of the 203A tube in Class B with 1000 volts on the plate,

1250 ohms load, and 35 volts bias, illustrates the variation in grid impedance when the tube is driven positive. With 20 volts positive on the grid the grid current slope indicates a resistance of about +3200 ohms. With 80 volts, this is -2500 ohms and at maximum output (120 volts) +600 ohms.

As a general design consideration, the input impedance to the grids of Class A prime or Class B tubes should be approximately 20% of the minimum instantaneous grid resistance. This is particularly impor-

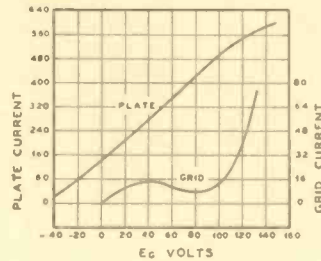

FIG. 1  
203A Operating Characteristics

tant in those tubes which have negative grid resistance, as a source of impedance higher than the negative grid resistance will tend to produce parasitic oscillations which besides distorting the signal may break down the output transformer insulation.

The design of the input transformer is easily generalized. After the type of output tube and its operating conditions are chosen, the peak grid swing for maximum output must be determined. We then determine the peak plate swing of the driver tube or tubes. The ratio of the input transformer (total primary to 1/2 secondary) should be equal to the ratio of driver peak plate swing to output peak grid swing. As an example, let us take the case of Push pull 59 tubes driving 845 A prime tubes as used in the writer's article in the November issue of "RADIO", but applied to a transmitter modulator (Fig. 2). The peak grid swing is approximately 300 volts. The peak plate swing of the 59 tube is about 180 volts with 275 volts on the plate and slight overbias.

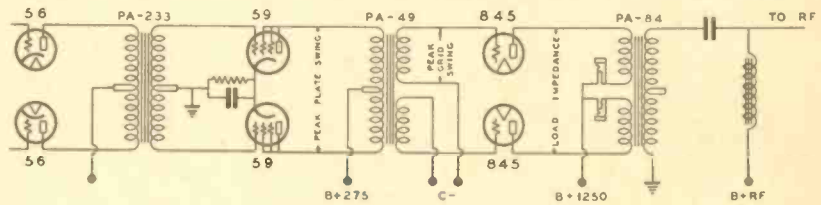

FIG. 2  
A-Prime 845s used for High-Level Plate Modulation

As the 59's are connected in push pull, the plate to plate swing is 360 volts. The ratio of peak plate swing to peak grid swing is therefore

$$\frac{360}{300} \text{ or about } 1.2$$

and consequently the input transformer turns ratio is approximately 1.2:1 from total primary to 1/2 the secondary. Since the impedance ratio of a transformer varies as the square of the turns, 1.2<sup>2</sup> or 1.44 is the ratio of impedance from driver to each grid. The 59 plate resistance is 2300 ohms, or 4600 ohms for push pull tubes. Therefore,

$$\frac{4600}{1.44} = 3200 \text{ ohms}$$

as the reflected load in series with each grid. It is apparent that with a series grid impedance of such high magnitude, the grids cannot be driven very much positive without exceeding the 20% ratio of series impedance to grid impedance referred to above. If lower resistance driver tubes were used, or tubes having a greater plate swing and a higher stepdown ratio input transformer were used, the series impedance reflected to the grid circuit would be lower, and higher undistorted grid swings with resultant higher output power would be possible. However, the maximum plate dissipation of the tube normally sets the limit for maximum output without decrease in tube life.

In the Class B tubes most frequently used by the amateur such as the 46, 800, etc., the grid bias is normally low. This effects a comparatively low grid swing, a corresponding high input transformer stepdown ratio, and small grid power. However, in the case of A prime tubes, this grid swing is normally high and the amount of driving power required is also high. Generally, the driving power available should lie between 6 and 11% of the maximum output from the output tubes.

The best load impedance for Class A prime tubes is somewhat difficult to calculate accurately. As in Class B, for a limited grid voltage the output power will be greatest when a plate load is chosen such that the product of plate voltage swing and plate current swing is a maximum. For maximum power with minimum distortion, the load resistance will decrease as the driver power is increased. In other words, with greater driving power, the plate current swing on the output tube can be increased and greater power output will consequently be developed across a smaller resistor. This again is governed by the peak current which the plate supply can deliver. It is also not desirable to use a low load resistance if the plate supply regulation is bad. All these factors are of more or less importance depending upon the magnitude of values in the particular design. However, a general method of determining load impedance for push

pull tubes can be used where the grids are not driven very positive. Fig. 3 shows this as applied to the 845 tubes. The published plate characteristic curve must be obtained and an operating voltage  $E_b$  selected. A vertical is erected at  $.6E_b$  and the  $E_c = 0$  line is extended to meet it. A line is then drawn from this point of intersection to our point  $E_b$ . The slope of this line multiplied by 4 is the proper plate to plate load. In the example drawn, this load is equal to

$$\frac{1250 - 750}{400} \times 4 = 5000 \text{ ohms.}$$

If the grids are driven sufficiently positive

\*Chief Engineer, United Transformer Corp.



to make the normal output about four times that of a single sides Class A amplifier using the same tube, this value of load impedance should be reduced by about 20%. If the plate supply regulation is better than 10%, this load impedance can be reduced another 5%. In the case shown, this would mean an effective plate load of 3750 ohms. The

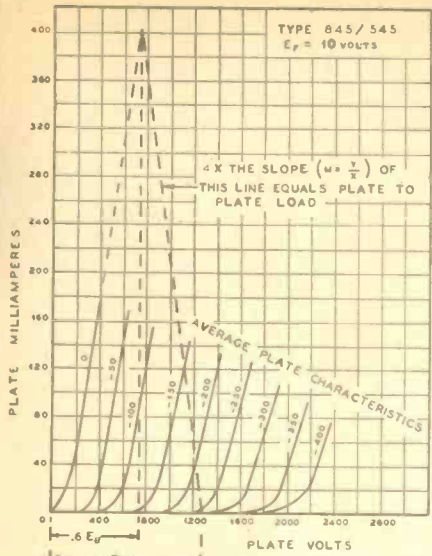

FIG. 3

Method of Graphically Computing Proper Load Impedance (see text)

recommended RCA value is approximately this value.

The calculation of maximum power output is also not difficult. The output is equal to Max. plate current  $\times$  plate voltage

$$\text{Power} = \frac{.40 \times 1250}{5} = 100 \text{ watts}$$

If the above notes are summarized, it is seen that A prime amplification is a system lying between Class A and Class B. High plate efficiency is obtainable, but not quite as high as Class B since the tube is not biased near cutoff. The grid is normally harder to drive in Class A prime than in the average corresponding Class B system, but it need not be driven positive as far. Not all tubes are suitable for A prime operation. Those most commonly used in this

manner are the 42, 245, 2A3, 210, 250, 841, 845, WE 284A, 849.

It should be remembered that the leakage reactance of the driver transformer is added to the input impedance in series with the output grid. It is therefore highly imperative that this leakage reactance be kept low. As an example of this, let us take the case of 849 tubes. Operated in A prime with 3000 volts on the plate, and driven with 845's, for output of 400 watts, the grid impedance goes as low as 1000 ohms. A leakage inductance of only 30 Milhenries would at 5000 cycles result in an additional series impedance of 1000 ohms. This would naturally reduce the amount of undistorted power output very appreciably. Leakage reactance in the output transformer is also very important.

The importance of the design of input and output transformers is well indicated by RCA when, in describing their 1D transmitter using 849 audio output tubes, they state that the audio transformers are de-

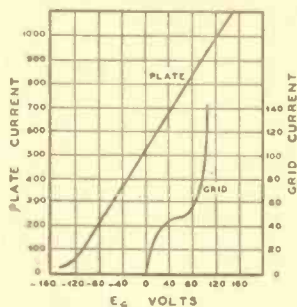

FIG. 4

849 Operating Characteristics

signed to be the best possible, regardless of size or cost.

The amateur normally operates his tubes above the manufacturer's rating. This is all right for A prime work, as the increased bias condition will normally reduce the plate current to a point where the peak plate dissipation of the tube is not exceeded. However, this should not be done to excess. If possible a meter should be located in the plate circuit of the output tube to indicate the maximum peak plate current. The writer has seen 250 tubes driven to .5 ampere peak plate current, but the tube life has been distressingly short; measurable in minutes, not hours. If tubes are operated above normal rated plate voltage, the load resistance should be increased somewhat to take ad-

vantage of the higher plate voltage swing available. The bias voltage should be adjusted so that the plate current per tube lies between  $\frac{3}{8}$  and  $\frac{3}{4}$  of the normal Class A plate current. For perfect overlap of power between the two push pull tubes, the plate currents should be adjusted to be identical. The methods of obtaining adjustable bias have been well covered in previous issues of this publication.

The 849 tubes are being used extensively now for high fidelity transmitter operation. Operated in Class A prime, biased almost to Class B operation, a power output of 950 watts is obtainable with 3000 volts on the plate. This is sufficient audio power for a 1000 watt transmitter using high level plate modulation. The tube characteristics are shown in Fig. 4. Fig. 5 illustrates a typical complete circuit for an output stage used in broadcast transmission. The circuit is similar to an equivalent Class B setup. However, the slightly reduced bias allows a greater no signal plate current and a reduction in harmonic content at low levels. 845 tubes operated A prime are used to drive the 849s. Adjustable fixed bias is applied to both driver and output grids. The duplex plate supply shown delivers 3000 volts for the 849 tubes and 1250 volts for the 845s. The grid resistors in the 849 circuits tend to stabilize the load reflected to the driver tubes and the grid condensers and series plate resistors in the output stage tend to eliminate the possibility of parasitic oscillations. The regulation of both plate and bias supply is extremely good. The overall gain of this output stage is 27 DB. Using high quality audio components the frequency characteristic of this output system is uniform from 30 to 12,000 cycles.

All in all, it appears that A prime is now finding its place in both the transmitting and public address fields. With proper care in design, the advantages of both Class A and Class B can be fully obtained.

## NEW BOOKS

AND REVIEWS OF CATALOGS

### All-Wave Receiver Design

THREE handy size books on receiver design have just been published by Manson Publishing Co. of 521 Fifth avenue, New York. These books were written by the well known authority on modern superheterodyne design, Mr. G. S. Granger. The first book covers All-Wave Receiver Design and is most complete and comprehensive. It is up-to-date. The very newest and most desirable features are covered. The discussion of antennas and antenna coupling circuits is especially valuable. AVC systems, including amplified and delayed systems, are very completely treated. Fundamentals of oscillator design and IF amplifier design are treated in an entirely new manner. Crystal filters are described, as is shielding. The problem involved in tracking high-frequency tuning circuits is completely discussed.

The second book is entitled Broadcast Receiver Design. It covers problems of selectivity and image suppression, detectors, oscillators, antenna coupling circuits, oscillator tracking, hum elimination, AVC and Squelch circuits, Class A, B, and AB audio amplification and power supplies. The author uses several examples of modern receiver circuits to illustrate his points. Some very interesting image suppression circuits are described and discussed.

The third book considers the special problems involved in High Fidelity Receiver Design. The newest High Fidelity Philco receiver is used to explain many of the considerations involved. The book covers acoustic considerations, audio amplifiers, automatic tone control, band pass filters and IF and RF band pass requirements, variable selectivity, detectors, oscillators, AVC and QAVC, speakers and residual thermal noise effects.

All three books avoid complex mathematics and will appeal to the amateur, service man, set builder and SWL, as well as to the advanced radio engineer. The books retail for 50-cents each.

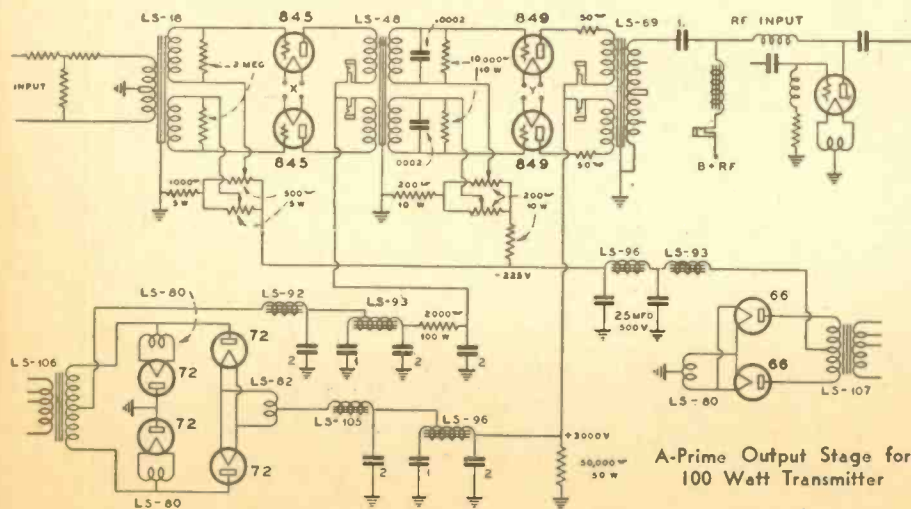

FIG. 5.

The 849 bias should be adjusted so that the no-signal plate current is 40 MA. per tube for Class A-Prime operation, or 10 MA. per tube for Class B operation. Other constants are not altered.

# Analyzing The New RCA-ACR Amateur Communications Receiver

THE first RCA superheterodyne was presented in 1924 when the radio boom was in the making, and when the congestion on the BCL bands became so aggravated that something better than a TRF receiver was necessary. Superheterodynes proved their worth during the world war, when the invention of Major Armstrong was used to intercept signals from the German army stations.

After ten years of constant improvement, RCA deemed it timely to recognize the needs of the amateur. Therefore the RCA ACR-136 Amateur Communications Receiver is here presented.

It is a seven-tube superheterodyne that gives full coverage and continuous band-spread from 540 to 18,000 KC. Interpreted in wavelengths, the range is from 550 to 16 meters. Sharply-tuned preselection, automatic gain control with on-off switch, efficient front-of-panel band switching, and positive calibration of the band-spread dial are some of the outstanding features.

The first new feature which greets those who study the circuit diagram is the high-frequency coil-switching arrangement. The switch for coil changing is a 10-pole-triple-throw, which not only switches both the primaries and the secondaries of all the RF, detector and oscillator coils, but also short-circuits those unused coils which otherwise would cause dead spots in some of the tuning ranges.

The tuning coils were developed after extensive research into various form factors, wire sizes, etc. A liberal amount of shielding is used between coils in order that high gain and selectivity can be obtained without the difficulties often caused by regeneration and intercoupling.

Each RF and detector coil has its own trimming condenser and each oscillator coil has individual trimming and padding condensers, which enables the alignment and the tracking to be held to quite accurate limits over the entire high-frequency spectrum. The coil-switching assembly is the "Magic Brain" which has been given such

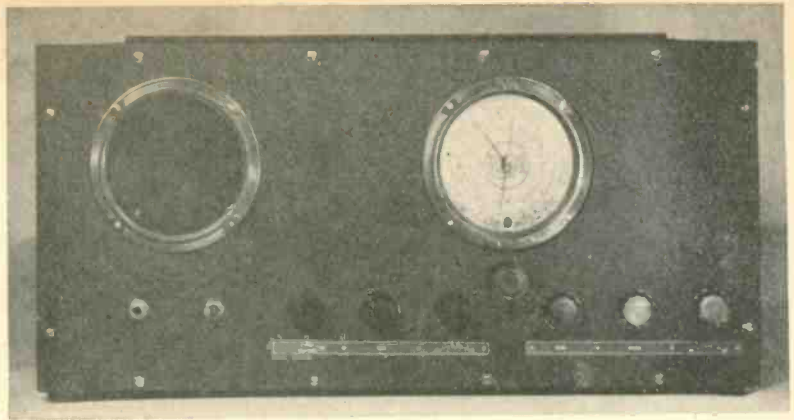

The Control Panel of the RCA ACR-136 Is Conveniently Laid Out

wide publicity by RCA in its advertising of the new RCA-Victor all-wave BCL line.

The RF stage consists of a 6D6, the advantages of which, as a high frequency RF amplifier tube, were made known for the first time by "RADIO" sixteen months ago. The 6D6 stage has a 4,000 ohm variable cathode bias resistor which is used as an RF sensitivity control and permits of wide range of the AVC action. It is almost impossible to obtain effective AVC action when the AVC system must be designed so as to prevent overload of the first RF tube when the receiver is located within a few blocks of a high-power broadcast station. If some measure of manual sensitivity control can be applied to the first tube in any receiver, the designer is then enabled to utilize a much more effective AVC system. If the AVC alone were required to handle signals as strong as 1 volt across the antenna and ground terminals, serious compromises would be necessary. These compromises would affect the maximum available sensitivity of the receiver and the range of the AVC system itself.

In the model ACR-136, AVC is supplied to the RF amplifier, first detector and the IF

amplifier tube, although the manual sensitivity control affects only the first RF tube.

Grids Nos. 1 and 2 of the 6A7 tube comprise the oscillator portion of this combination electron-coupled oscillator and detector tube, and the circuit used is somewhat new. It was designed to give approximately-constant oscillator output over the entire frequency range of the receiver. Thus it avoids the wide variations in sensitivity so often found in conventional all-wave superheterodynes, due to the variation in oscillator voltage output with frequency.

Although only one IF stage is used, the special transformers in this receiver enable a truly surprising amount of sensitivity and gain to be realized from this single stage of intermediate amplification.

The second detector tube is a 6B7, a double-diode-pentode. One diode of the 6B7 is used for detection and AVC rectification; the other diode is used to introduce the out-

(Continued on page 34)

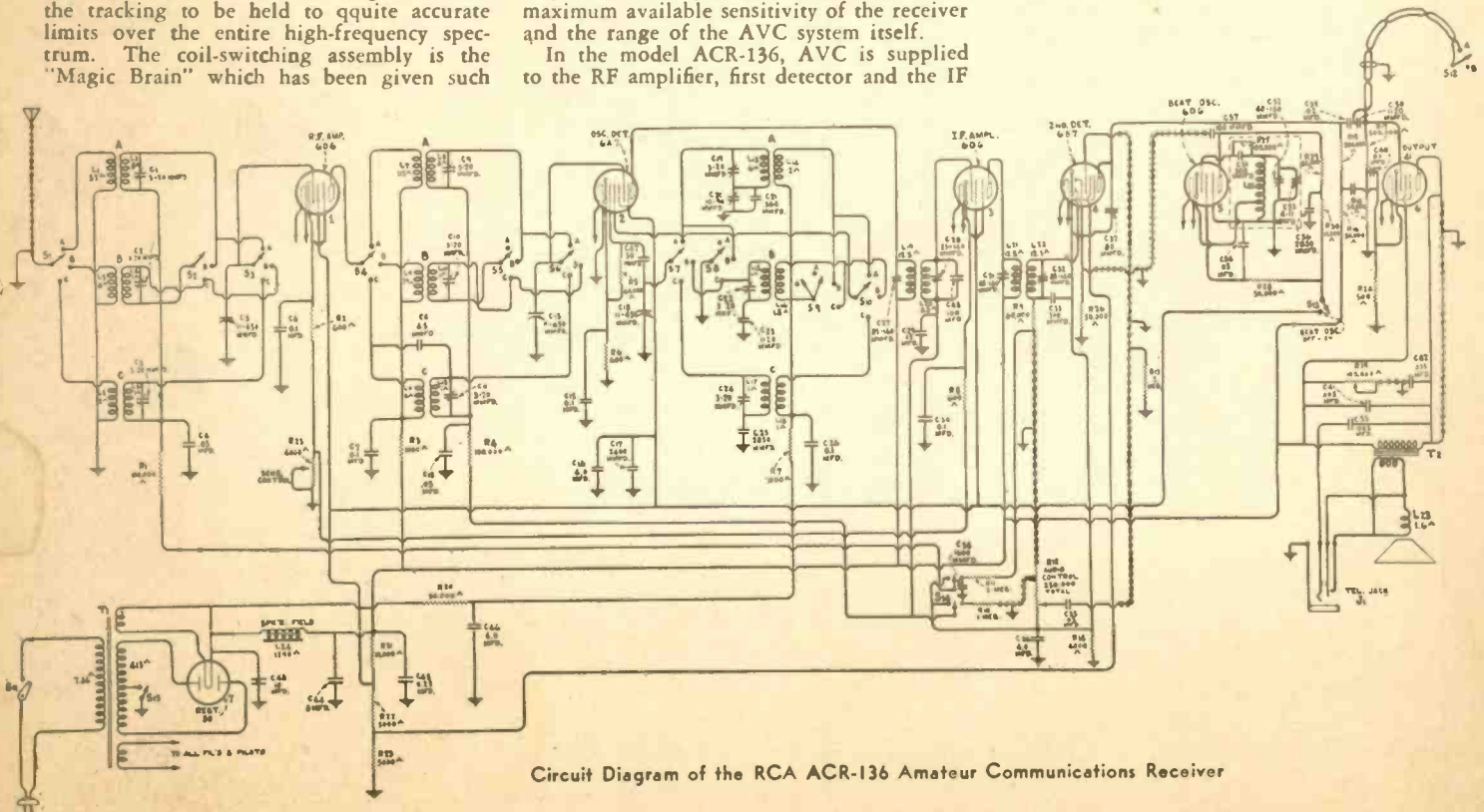

Circuit Diagram of the RCA ACR-136 Amateur Communications Receiver

# Driving the New 150-T to 400 Watts With a 210

● Some amateur constructors are confronted with the problem of space limitation, thus necessitating the use of capacitive coupling instead of link coupling. In order to determine how much excitation is required for the 150-T, a capacitive coupled exciter unit was built, photographs and circuit diagram of which are here shown. A 47 tube is used for the crystal oscillator. The voltage of this tube is stepped down by means of a drop across one-half of the split-stator oscillator tuning condenser. This enables an effective impedance match to be obtained between the high impedance plate circuit of the 47 tube and the low impedance grid circuit of the 841 tube, which is used as the first buffer-doubler.

Grid-leak bias is used on the 841 tube and the transmitter is keyed in the center-tap of this stage. The output of the 841 tube is capacitively coupled to a 210 tube driver stage which, in turn, is link-coupled to the 150-T final amplifier stage. In order to prevent excessive plate current on the 210 stage when the key is up, cathode bias is used for the purpose of keeping the bias independent of the excitation. The 210 stage, running at 500 volts and 85 milliamperes (approximately 43 watts input), drives the grid current of the 150-T at 40 milliamperes. The bias on the final amplifier is 400 volts and is obtained from a 5Z3 rectifier filter circuit in order to avoid the use of batteries.

The 150-T is operated with 2,000 volts on the plate at 200 milliamperes, or 400 watts of input. No accurate measurement of power output was made, but approximate measurements by means of electric lamp bulbs used as a dummy antenna indicated about 325 watts of output.

The oscillator, buffer-doubler and driver stages are mounted on a sand-blasted aluminum chassis, 10 inches deep, 24 inches long and 2 inches high. The chassis for the final amplifier is of the same size, and is mounted directly above the driver unit; the two units in turn are mounted in a rack and the power supply units occupy the two lower shelves. Connections between the power supplies and the RF chassis are by means of cabled leads, shielded with Lenz braid.

## The Coupling Link

● The link around the plate coil, when link coupling is used, constitutes the secondary of a step-down transformer, just as the link around the succeeding grid coil constitutes the primary of a set-up transformer. Very high transformer efficiency is desired; this means that transformer losses must be minimized. The losses in a radio-frequency transformer increase as the ratio of transformation increases. In other words, the greater the step-

## ★ A Modern, Highly Efficient Transmitter— With a Practical Capacity-Coupled Crystal Oscillator Stage

● The Final Amplifier using a single 150-T. A Graphite Plate 210 tube, with 750 volts of plate voltage, drives the grid current of the 150-T to 40 milliamperes. The unit is mounted on a sand-blasted aluminum chassis. The antenna coil is wound on the same form on which the plate coil is wound, as the picture shows.

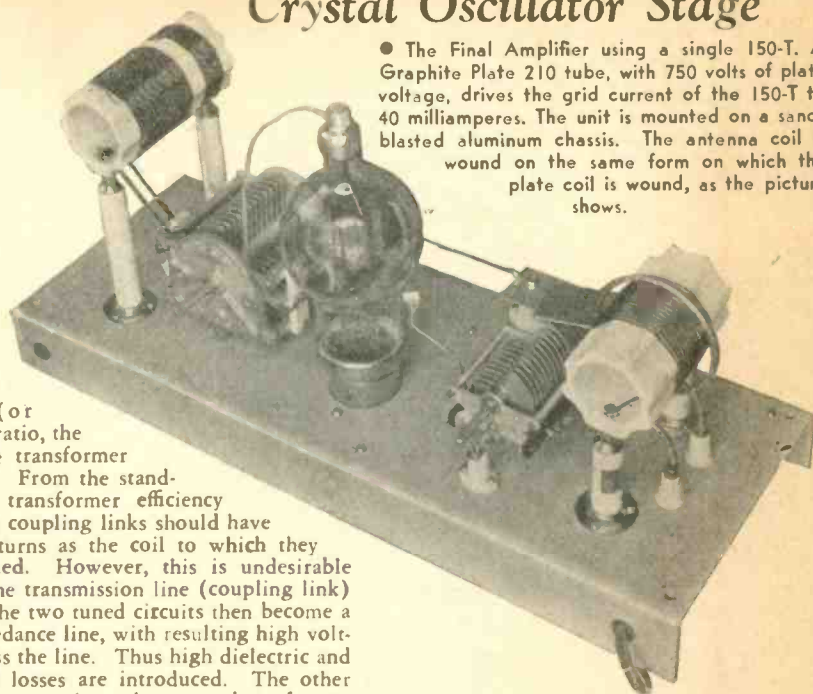

down (or step-up) ratio, the lower the transformer efficiency. From the standpoint of transformer efficiency alone, the coupling links should have as many turns as the coil to which they are coupled. However, this is undesirable because the transmission line (coupling link) between the two tuned circuits then become a high-impedance line, with resulting high voltages across the line. Thus high dielectric and insulation losses are introduced. The other reason for not using a large number of turns when coupling the link circuit to the tuned tank circuits is because it is almost impossible

to avoid a large amount of capacitive coupling in addition to the desired inductive coupling.  
(Continued on page 20)

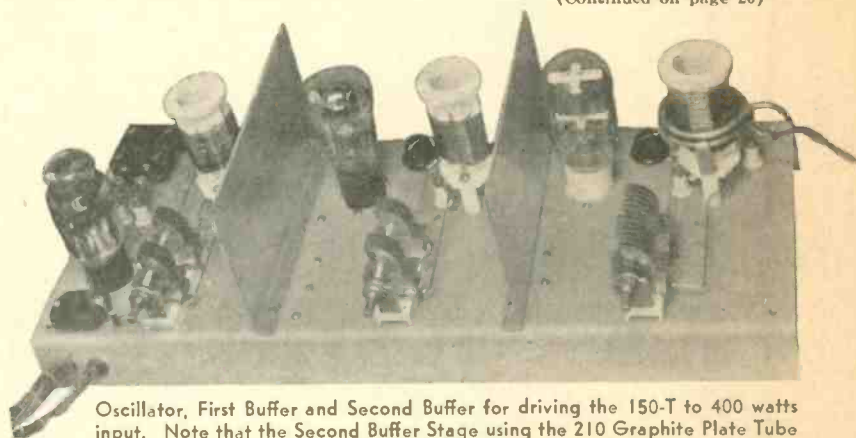

Oscillator, First Buffer and Second Buffer for driving the 150-T to 400 watts input. Note that the Second Buffer Stage using the 210 Graphite Plate Tube has two turns around the Plate Coil for the Link-Coupling Loop. The equipment here shown was built by W6AWT for W6DAP.

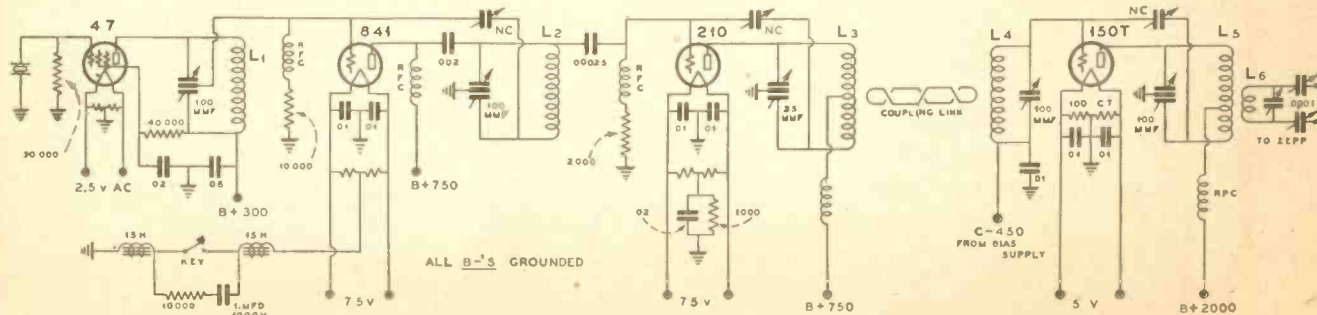

Complete Circuit Diagram for 400 Watt 4-Tube Combination Capacitive and Link-Coupled Transmitter

Coil Winding Data for 40-meter operation: L1—Oscillator Plate Coil, 15 turns No. 18 enameled wire, spaced one diameter, wound on 1 1/2" Ceramic Coil Form.  
L2—First Buffer-Doubler Plate Coil, 18 turns, No. 18 enameled wire, spaced one diameter, wound on 1 1/2" dia. Ceramic Coil Form.

L3—Second Buffer Plate Coil, 31 turns, No. 18 enameled wire, spaced one diameter, tap taken at 16th turn from +B connection. Coil form used is 1 1/2" dia. Ceramic.  
L4—Final Amplifier Grid Coil, 16 turns, No. 14 enameled wire, space wound on General Radio 2 1/2" Ceramic Coil Form.

L5—Final Amplifier Plate Coil, 19 turns, No. 12 enameled wire, space wound on 2 1/2" dia. Ceramic Coil Form. Tap taken at 10th turn for +B connection.  
L6—Antenna Coupling Coil, wound on same form as L5, 5 turns, No. 12 enameled wire, space wound.  
NC—Final Amplifier Neutralizing Condenser, 2 aluminum plates, 1 1/4 square inches each, spaced 3/8 inch apart.

## The New 150-T

(Continued from page 19)

This capacitive coupling sometimes "bucks" the inductive coupling and thus reduces the transfer of power. Its principal disadvantage is that it causes a large amount of interlock between the tuning condensers of the two tuned circuits. Thus when one circuit is tuned to resonance it usually detunes the other circuit, and it then becomes impossible to maintain both circuits at exact resonance.

The best compromise between these opposing factors seems to be the use of not more than two turns for the loop at each end of the transmission line. These loops are coupled closely to the cold end of each tuned tank circuit. The cold end is that end closest to ground, insofar as r.f. is concerned. When a split-tank stage is used, the ground point on the coil is located at the center of the coil, and the coupling link should be placed as close to the center as possible. Lamp cord or stranded wire should not be used for the coupling link or transmission line, due to excessive r.f. losses. A very good line can be made from No. 14 rubber covered wire, whose insulation is sufficient to enable the coupling link to be wrapped directly around the tank coils of all stages using less than 1000 volts plate voltage. The link, therefore, is self-supporting.

In general, the same number of turns should be used at each end of the coupling link, provided they both have the same diameter. Any transmission line must be terminated in equal impedances at both ends in order to avoid reflection losses.

## Methods of Varying Grid Excitation

The coupling link should always be located so that it transfers maximum energy from the plate circuit of a driver tube to the grid circuit of a driven tube.

The conditions under which the driver tube operates can be varied by changing the location of the coupling link with respect to the two tuned tank coils. When loose coupling is used to the plate circuit of the driver tube, the driver tube works into a high load impedance, which is necessary with tubes having a high internal plate resistance, such as the 47, 865, 46, 841 or 203A. On the other hand, if the coupling to the plate coil of the driver tube is quite close and the coupling to the grid coil of the driven tube is loose, the driver tube then works into a low value of plate impedance. This condition is desirable under certain conditions when the driver tube is one having a low internal plate resistance, such as the 45, 2A3, 845, 150T, 50T. In general, when working out of tubes having a medium plate resistance, such as the 210, 211, 852, etc., the coupling at each end of the coupling line should be approximately equal.

This principle is affected by the grid impedance of the driven tube. Tubes such as the 03A, 46, 841, and 865 have a very low grid impedance. Consequently, when driven by a tube having high internal plate resistance, considerable overall step-down is necessary between the plate tank and the grid tank in order to provide maximum energy transfer.

## HK-354

(Continued from page 14)

The shielding cone, which shields the plate from the filament, makes the HK-354 the only transmitting tube that can be operated at high frequencies in the grounded-grid circuit without danger from feed-back or self-oscillation. The grounded-grid circuit requires no neutralization, although somewhat more grid excitation is necessary for a given power output, due to the degenerative effect of the plate current which flows through the grid coil in a direction which bucks the grid excitation.

At a conservative plate efficiency of 66%, 300 watts of output can be secured from one HK-354 at a plate voltage of 3,000 volts without exceeding the plate current and dissipation ratings of the tube.

This tube has recently found wide application in the field of diathermy therapeutic equipment. This equipment usually consists of an ultra-high frequency oscillator which is used to produce internal heat or "local fevers" in various portions of the human body by means of the dielectric loss in that portion of the body which is placed in the field of the tank condenser. The tank condenser is usually equipped with flexible leads and is highly insulated, and isolated from the DC plate voltage so that the patient can place portions of his body between the two plates and thus utilize the diathermic heat caused by the patient's own dielectric loss.

## New RK-23 Raytheon Tube Used in McMurdo Silver Transmitter

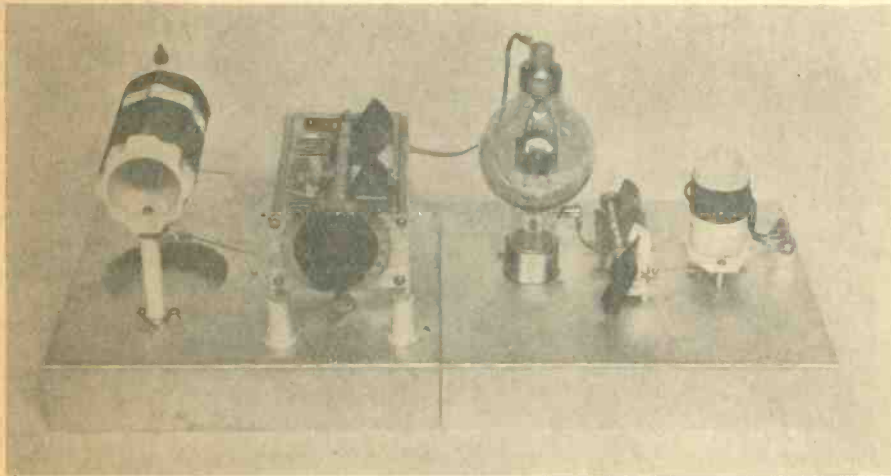

EIMAC 50-T Driver Stage for Final Amplifier

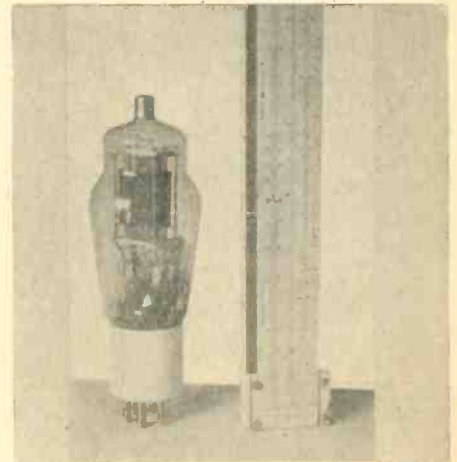

The 10-Watt RK-23 Pentode

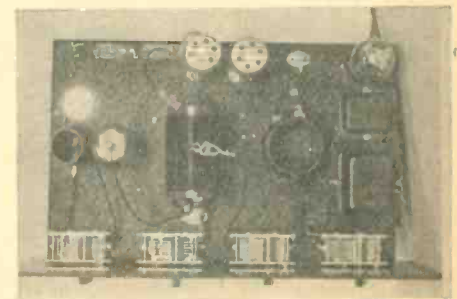

Experimental McMurdo Silver Transmitter using new RK-23



Front view of Laboratory Transmitter

## Push-Pull vs. Parallel Operation

(Continued from page 7)

increasing ten times. From the table, the indication is that we should expect at least a 50% plate efficiency when we use a pair of 46's in push-pull with the plate voltage below 450 volts. The driving power used runs from 0.1 watt to 1 watt. From the table, it seems that 1.0 watt is the least we should expect in the grid circuit.

Changing the circuit from push-pull to parallel connection and going through the same test procedure, we obtain the results shown in Table II.

Here is a surprise indeed—an average of two-watts lower input with the parallel connection of a pair of 46's driven from some external circuit and with the same grid voltages and grid currents as in the push-pull arrangement. Another thing noticed is that there is a best grid resistance; in this case, 6000 ohms. At this point, the plate efficiency

is highest for the combination. This really means that —60 volts should be applied to the grids of a pair of parallel-operated 46's drawing 10 mills of grid current.

From the push-pull table, we suspect, if the grid resistor were increased in value, that the input watts would perhaps come down to the same value as in parallel operation but that the watts lost in the grid resistor would also go up in value. What we wanted to know was what would happen if we kept both conditions alike; parallel connection wins out by a couple of watts.

The writer has enjoyed making this determination but realizes that errors can creep in. He has, however, been as careful as he possibly could be. There will be amateurs who are sure that there should be no difference between push-pull and parallel operation as input and output are concerned; nevertheless, the author can only report results as he found them.

# Power Modulation and Efficiency Modulation

By NORRIS HAWKINS, W6AAR

**A**MPLITUDE modulation has been defined as a "moulding" or variation of the amplitude of a constant frequency radio-frequency carrier in such a manner that the audio frequency voice waveform is superimposed on the radio-frequency wave. Thus the outline, or envelope, of the combined waves is an exact reproduction of the original audio frequencies which are impressed on the microphone.

There is a wide variety of methods by which this modulation process can be affected, but this discussion will be limited to those methods that give linear and symmetrical 100 per cent modulation capability. Thus absorption, or loop modulation, is automatically eliminated from consideration and the treatise will be limited to modulation of some DC voltage applied to an electrode of a vacuum tube amplifier.

## Power Modulation

The general classification of power modulation includes all forms of plate modulation because power modulation involves the modulation of the source of power which is converted into RF carrier power by a vacuum tube amplifier. A radio-frequency class C amplifier usually operates under conditions such that the power output varies as the square of the plate voltage. Thus the RF voltage output varies exactly as the plate voltage is varied. Ordinarily, all modulated class C amplifiers operate at a practically constant plate efficiency, but with a peak plate input varying above and below the normal unmodulated value in accordance with the audio-frequency AC supplied by the modulator. The plate efficiency of a plate modulated class C amplifier can be made quite high; 92 per cent has been reached in laboratory amplifiers, although 65 per cent to 85 per cent is more common in modern amateur stations.

A study of the power distribution in a completely modulated wave shows that two-thirds of the total power consists of the carrier, and the other one-third is divided equally between the two sidebands. Thus the average RF power output must be increased 50 per cent for complete 100 per cent modulation, and proportionately less for lower percentages of modulation.

The plate efficiency remains approximately constant during plate, or power modulation, and thus the RF power output can be increased only by increasing the plate input power during modulation. In order to get a 50 per cent increase in average power output during complete modulation, the plate power input must also be increased by 50 per cent. Because the audio frequency modulator, or modulators, are the sole source of this increase in power, it is seen that the maximum undistorted power output of the modulators must be equal to 50 per cent of the constant DC plate input supplied to the unmodulated class C RF amplifier. The modulator, or modulators, must be coupled in the circuit between the source of DC plate power and to the class C amplifier in such a way that the peak AC voltage output and peak AC current output of the modulators just equals the unmodulated DC plate voltage and plate current. Under complete modulation, therefore, the constant DC plate input is alternately doubled and neutralized as the audio frequency AC wave goes through its maximum positive and negative values. This shows that the impedance of the load represented by the class C plate circuit and the impedance the AC power source which is

the modulator tube, or tubes, must be matched to each other if the AC voltages and currents are to exactly double and then neutralize the constant DC voltage and current, which represents the unmodulated plate input power to the class C amplifier. It is not sufficient that the modulator tube, or tubes, be capable of a maximum undistorted output equal to 50 per cent of the DC plate input; the coupling device, whether it be a choke, condenser or audio transformer, must be designed so that the class C load reflects back the optimum value of load resistance into the plate circuit of the modulator tubes.

Power modulation is by far the most popular method of modulation, largely because it requires few critical adjustments to obtain high audio quality, power output and plate efficiency. It requires rather large modulator tubes, but the development of class B and class A prime audio amplifiers has allowed large amounts of audio power to be realized from small tubes. High-efficiency modulators require the use of plate power supplies of good voltage regulation with variations of load current, because class B and class A prime modulators do not draw a constant plate current as the audio signal varies. Instead, modulator plate current can vary as much as 1,000 per cent or more, depending on the amplitude of the audio-frequency signal voltage applied to the grid circuit of the modulator. This necessity for better voltage regulation has somewhat increased the cost of the average plate power supply and, in some degree, offsets the economies realized by the use of high modulator plate efficiency. Low resistance power transformers and chokes become necessary, and a swinging input choke is often required to still further improve the voltage regulation of the power supply. This swinging input choke adds but little to the hum filtering but tends to increase the DC output voltage as the load current increases, because the RAC power supply and filter with swinging choke act as a choke input device at low load currents and a condenser input device at high load currents.

## Efficiency Modulation

The average power in an RF wave increases during modulation, up to 50% for complete 100% modulation. This additional power output must be released to the antenna circuit in exact accordance with the variations in sound pressure applied to the microphone. There are two ways in which the power output of a radio-frequency amplifier can be increased. First, the plate input power can be increased, keeping the efficiency of conversion into AC RF power constant, in which case the RF power output must faithfully follow any variation in plate power input. This method was previously described and is termed **POWER MODULATION**. Second, the plate input can be left constant and the efficiency of conversion can be varied at an audio frequency rate, which will also result in the desired increase in RF power output. While the average power output only increases 50% during complete 100% modulation, the peak power output alternately swings from normal to four times normal, then down to zero and back to normal during each audio frequency cycle. Thus the instantaneous plate efficiency, in an efficiency modulated amplifier, must vary between zero and twice the unmodulated efficiency if complete modulation efficiency is desired.

The average plate efficiency must increase

50 per cent, during complete modulation of an efficiency modulated RF amplifier, and the average plate efficiency can never exceed 75 per cent. Thus the unmodulated plate efficiency must be something less than 50% in all efficiency-modulated devices.

Efficiency modulated amplifiers include practically all forms of grid modulated amplifiers, whether they are modulated by variable excitation, in which case they are usually termed **Liner Amplifiers**, or whether they are modulated by variable grid bias, in which case they are called **Grid Bias Modulated Amplifiers**.

In order to gain a better understanding of the fundamental nature of efficiency modulation, it is necessary to get a somewhat new conception of the common radio-frequency amplifier. In the first place, it is not an amplifier at all. For example, a vacuum tube amplifier does not take the AC voltage applied to the grid and actually amplify it by adding something to it. It merely acts as a relay, or grid-controlled power convertor and releases power from an outside source in accordance with the control exercised by the control grid. If the control grid says, "Release 75% of your DC input in the form of AC power with a frequency of 7000 kilocycles", the plate circuit merely obeys orders and changes its internal resistance enough—and often enough—so that a varying current is drawn through an external load impedance, across which the AC output voltage of the desired amplitude and frequency appears. None of the power applied to the control grid appears in the plate circuit; it is all dissipated entirely in the grid circuit in exercising the desired control over the power released, or converted by the plate circuit. Thus the conception of **Power Amplification** by means of a vacuum tube should probably be superseded by a conception of **Grid Controlled Power Conversion** in which the grid voltage merely controls the efficiency and frequency of conversion of DC plate input power into AC output power. The control grid may be said to control either the efficiency of conversion or the amplitude of output, both of which amount to the same thing.

Thus if a vacuum tube power converter (or amplifier stage, as it is commonly termed) is operated under such conditions that it has an efficiency of conversion of direct current into radio-frequency alternating current of something less than 50%, then the radio frequency power output can be modulated or varied by merely changing the efficiency of conversion, without affecting the DC power drawn from the external power supply. Thus the amplitude modulation of a radio frequency wave can be effected with only enough audio power to vary the peak amplitude of the control grid AC voltage. Of course, the efficiency of conversion can also be varied by varying a DC voltage applied to either a screen-grid or a suppressor-grid in a multi-element vacuum tube.

## Grid Bias Modulation

When the axis of the AC grid excitation voltage is shifted by the audio frequency modulating voltage, it is termed **grid bias modulation**. If the control grid of the modulated tube draws any DC grid current, then enough audio must be supplied from the modulator tube to modulate this DC grid current. Usually this current is quite small in comparison to the DC plate current and a real economy of required audio power can be effected by using grid-bias modulation instead of plate-power modulation. Un-

(Continued on page 35)

# A Comprehensive Report of the Melbourne Centenary International DX Contest

Submitted By ELMER H. CONKLIN, W9FM

## Editor's Note—

Many a "VK" and many a "W" amateur will welcome this complete report of the Centenary Contest. It is one of the best reports of DX yet received by this magazine.

## Log of Melbourne Centenary International DX Contest, 1934

Name—Elmer H. Conklin  
512 N. Main Street  
Wheaton, Illinois  
Call—W9FM

Transmitter—2X852c crystal controlled. Input to P.A.: 500 to 600 watts.  
Receiver—National FBX-A  
Aerial—Transmitting: 260-foot East-West Wire.  
Aerial—Receiving: 66-foot tuned, 2-wire feed.

512 N. Main Street  
Wheaton, Illinois, U.S.A.  
November 7, 1934.  
Wireless Institute of Australia,  
(Victoria Division)  
Kelvin Hall, Collins Place,  
Melbourne, Victoria.

### Gentlemen:

Herewith I submit my report of contacts made during the Melbourne Centenary International DX Contest. My score of 6000 is based upon mileages as figured by spherical trigonometry (see QST for March, 1928) and checked on a large globe with a scale of 250 miles per inch, so I guess they are reasonably accurate. The mileages are: (to Springfield, Illinois)

VK2, Sydney, N.S.W. 9155  
VK3, Melbourne, Victoria 9522  
VK4, Brisbane, Queensland 8806  
VK5, Adelaide, S. A. 9784  
VK6, Perth, W. A. 10890  
VK7, Hobart, Tasmania 9523

You will notice that some of the reports from Illinois and adjacent states give larger mileages, running up the score somewhat. Hold 'em down as well as you can. I may send you the actual figures in case you want to check them.

The report is not only the usual report, but one of calls heard and worked, and also a chart of frequencies of all VKs heard. The most stations worked in 1 hour is 5 (W9BT worked 6). The most in one morning is 19 (W9BT worked 23). Six districts heard and worked. 115 QSOs, 112 scoring contacts, 63 stations worked out of 117 heard. 54 stations heard were not worked, but many were not even called. Quite a few were heard only once. Seven were worked 4 times, 7 worked 3 times. Nine were called numerous times but not raised:

Worked 4 times—VK2DA, VK2OD, VK3GQ, VK3HL, VQ3JQ, VKDKX, VK7RC.  
Worked 3 times—VK2XU, VK2ZC, VK3EG, VK3MR, VK3OX, VK3RJ, VK4BB.

Often called, never raised—VK2NY, VK2FM, VK2AE, VK3WC, VK3UH, VK3HG, VK2KB, VK2AZ, VK6WJ.

I was not on the air quite all of the time, but most of it. On the last morning my relay blew up, letting WISZ work 25 per cent of his contacts. HI.

Since typing the above, I have found a more accurate source of getting the latitude and longitude of the Australian capitals and will have to adjust the distances some. Sydney seems off about 120 miles.

My signal strength reports in Australia, compared with W9TB, who was told twice that he was the loudest U.S.A. station, are:

W9FM		W9TB	
R9	0	R9	2
R8	3	R8	8
R7	9	R7	37
R6	39	R6	48
R5	41	R5	35
R4	15	R4	6
R3	5	R3	3

Average 112 R 5.36 Average 139 R 6.16

So W9TB put a signal 0.8 R better than mine into Australia. He used twice the power, antenna 55 feet high broadside to Australia, compared with my 600 to 600 watts into an antenna 38 to 28 feet high, end on to Australia. I don't feel bandy, as he chased me off the Preferred frequency, 7001 KC., which allowed him to make more QSOs.

Operating was good, an example being VK3YO who heard me call a VK on his frequency; when the VK2 didn't come back, VK3YQ called me. Usually the CQs of the VKs were too long. I did not raise a single VK on a CQ, though I did try it two or three times out of curiosity. I believe those in the middle of the band should finish a CQ with some indication of how they are going to tune, such as the proposal I make on a separate sheet re the frequency distribution of VKs. Some VKs were truly loud. Although some of them were only R6 when worked, they might get up to R8 or R9 between 6 a.m. and 7 a.m. VK7RO and some of the others actually were loud enough to throw the milliammeter needle (detector plate current) up to 0.6 ma. with each dot and dash!

(Continued on page 23, below concluding portion of Table)

Date and Time	My Freq.	FBX Dial	Stn. Wkd.	Serial Numbers Sent	Serial Numbers Recd.	T-QSA-R His Sigs.	My Sigs.	Dist. Miles	Pts.
10/6									
0808	7299	119	VK3EG	159,000	666852	9.5.2	9.5.7/8	9522	9
0816	7299	102	VK7RC	159666	852222	9.5.8	9.5.7	9523	9
0828	7299	86	VK4US	159852	292744	5.4.5	9.5.6	8806	8
0847	7299	100	VK5FM	159292	333252	9.5.6	8.5.6	9784	9
0914	7299	67	VK4RY	159333	444206	9.4.5	9.4.5	8806	8
				444					
0940	7299	98	VK4UU	159206	777242	5.5.6	9.5.5	8806	8
0954	7299	74	VK3OX	159777	424733	9.5.6	9.5.5	9522	9
1025	7299	107	VK3HL	159424	262333	9.5.8	9.5.6	9522	9
1057	7016	42	VK3KX	159262	276630	8.5.6	9.5.6	9522	9
1154	7016	38	VK2QV	159276	372232	9.5.7	9.5.7	9155	9
1218	7016	34	VK2XU	159372	514459	9.5.7	9.5.6	9155	9
1235	7016	30	VK5KG	159514	231252	7.4.5	9.4.4	9784	9
1259	7299	79	VK2QP	159231	663414	8.4.6	9.4.4	9155	9
10/7									
0709	7299	73	VK7KV	159663	765333	7.4.5	8.5.6	9523	9
0808	7299	86	VK2KA	159765	252744	9.5.7	9.4.5	9155	9
0834	7299	97	VK2OD	159252	222888	6.5.6	9.4.5	9155	9
0854	7016	55	VK3CS	159222	123789	8.5.6	6.5.6	9522	9
0933	7002	42	VK2XJ	159123	250821	9.5.7	9.5.7	9155	9
1009	7016	44	VK3GQ	159250	999321	9.5.8	9.4.6	9522	9
1025	7016	34	VK3JQ	159999	777852	8.5.7	9.4.5	9522	9
1038	7016	39	VK2DA	159777	777921	8.5.6	9.4.5	9155	9
1053	7016	48	VK3JO	159777	595333	9.4.7	9.3.3	9522	9
1107	7016	49	VK5MY	159595	313232	7.5.6	9.5.6	9784	9
1218	7299	111	VK2PH	159313	777214	4.5.7	9.4.5	9155	9
1245	7016	49	VK3YO	159777	122233	9.5.7	9.3.3	9522	9
1255	7016	53	VK5XU	159122	222841	4.5.6	9.5.5	9784	9
10/13									
0806	7016	38	VK2DA	159222	777888	8.5.8	9.5.6	9155	9
0806	7299	94	VK3BJ	159777	777552	8.5.8	9.5.6	9522	9
0912	7299	103	VK7RC	159777	852999	9.5.7	9.5.6	9532	9
0928	7299	72	VK4BB	159852	179333	9.4.7	9.4.5	8806	8
0938	7299	120	VK4UO	159179	777242	5.5.6	9.5.6	8806	8
0949	7299	86	VK2KA	159777	252574	9.5.6	9.5.6	9155	9
1011	7299	104	VK3HL	159252	262222	9.5.7	9.4.7	9522	9
1048	7299	121	VK3EG	159262	666222	8.5.7	9.5.8	9522	9
1137	7299	70	VK3RJ	159666	123712	9.5.7	9.5.6	9522	9
1145	7299	109	VK3CS	159123	123469	7.5.6	9.5.5	9522	9
1204	7016	52	VK5LX	159123	276333	9.5.8	9.5.6	9522	9
1225	7016	51	VK3KD	159276	737954	9.5.7	9.5.5	9784	9
1247	7016	46	VK6SA	159737	962333	9.5.7	9.4.4	10890	10
1303	7016	52	VK2XU	159962	514231	7.4.6	9.4.5	9155	9
1319	7016	51	VK2KJ	159614	233888	9.5.6	9.3.4	9155	9
10/14									
0715	7016	45	VK3GQ	159233	999744	9.5.7	9.5.6	9522	9
0739	7016	23	VK2ZC	159999	749829	9.5.6	9.5.5	9155	9
0759	7016	25	VK3BW	159749	123888	9.5.7	9.5.5	9522	9
0813	7016	31	VK2FX	159123	375121	9.4.5	9.4.4	9155	9
0848	7016	38	VK5MK	159375	—	—	—	—	—
0914	7016	34	VK3JQ	159375	777777	8.5.7	7.3.5	9522	9
0944	7299	94	VK2OD	159777	222222	6.5.7	9.5.7	9155	9
0959	7299	117	VK2BP	159222	233888	9.5.7	9.3.5	9155	9
1023	7299	115	VK3MR	159333	444224	9.5.7	9.5.8	9522	9
1034	7299	86	VK4US	159444	292888	5.4.5	9.5.6	8806	8
1048	7299	104	VK3DM	159292	111203	9.5.7	9.3.4	9522	9
1120	7299	107	VK3JJ	159111	555456	8.5.6	9.5.6	9522	9
1301	7016	34	VK2XC	159655	732379	9.5.7	9.5.6	9155	9
10/20									
0735	7299	116	VK3EG	159732	666555	8.5.7	9.5.7	9522	9
0749	7299	103	VK7RC	159666	852971	9.5.8	9.5.5	9523	9
0755	7299	114	VK3MR	159852	444888	9.5.7	9.5.5	9522	9
0803	7299	94	VK2OD	159444	222852	6.5.6	9.5.6	9155	9
0814	7299	88	VK3GU	159222	989111	8.5.6	9.5.5	9522	9
0904	7299	72	VK4BB	159989	179987	9.5.6	9.3.4	8806	8
0911	7299	105	VK3HL	159179	262459	9.5.7	9.4.7	9522	9
0926	7299	75	VK3OX	159262	424800	9.5.6	9.4.5	9522	9
0945	7300	77	VK5WP	159424	232888	7.4.5	9.4.5	9784	9
1006	7299	73	VK5RT	159232	050888	9.5.6	9.4.6	9784	9
1042	7299	109	VK3JJ	159050	555242	9.5.8	9.5.6	9522	9
1059	7002	23	VK2ZC	159555	749332	6.5.7	9.5.5	9155	9
1112	7002	53	VK3KX	159749	276384	8.5.8	9.4.4	9522	9
1131	7016	46	VK2CS	159276	789852	9.5.7	9.4.4	9155	9
1155	7002	54	VK2EO	159789	112223	9.5.6	9.5.7	9155	9
1228	7016	48	VK3JQ	159112	999242	9.5.7	9.5.6	9522	9
1258	7016	32	VK2FX	159999	375332	9.4.5	9.4.4	9155	9
10/21									
0831	7299	59	VK2NP	159375	275754	7.3.4	9.5.5	9155	9
0857	7299	71	VK3RJ	159275	123971	8.5.6	8.4.6	9522	9
0921	7002	34	VK2XC	159123	732333	9.5.8	9.4.6	9155	9
0937	7002	34	VK3JQ	159732	777738	8.5.6	9.4.5	9522	9
0955	7002	23	VK4JU	159777	777888	9.4.5	9.5.6	8806	8
1015	7002	22	VK2PH	159777	—	—	—	—	—
1045	7002	23	VK2RG	159777	878652	6.4.6	9.4.5	9155	9
1125	7016	33	VK2BS	159878	—	—	—	—	—
1255	7016	45	VK6SA	159878	962889	9.5.7	9.4.4	10890	10
1306	7016	53	VK3YO	159962	122242	9.5.7	9.4.5	9522	9
1331	7016	46	VK3HK	159122	358954	9.5.7	9.4.5	9522	9
1340	7016	44	VK7KJ	159353	765888	8.4.6	9.5.6	9523	9
1353	7016	39	VK2DA	159765	777852	9.5.8	9.4.5	9155	9

Date and Time	My Freq.	FBX Dial	Stn. Wkd.	Serial Numbers Sent	Serial Numbers Recd.	T-QSA--R		Dist. Miles	Pts.
						His Sigs.	My Sigs.		
10/27									
0710	7299	110	VK2BP	159777	333242	8.3.4	9.3.3	9155	9
0740	7299	103	VK3HL	159333	262777	9.4.5	9.4.6	9522	9
0810	7299	114	VK3MR	159262	444738	9.5.6	9.5.6	9522	9
0843	7299	69	VK4BB	159444	179513	9.4.5	9.4.4	8806	8
0856	7299	94	VK3BJ	159179	777113	7.5.6	9.5.5	9522	9
0920	7299	104	VK7RC	159777	852777	9.5.8	9.5.6	9532	9
0928	7299	96	VK2OD	159852	222469	6.4.5	9.4.6	9155	9
0938	7299	74	VK3OX	159222	424555	9.5.6	9.4.5	9522	9
1010	7016	52	VK2KJ	159424	233852	7.5.6	9.4.5	9155	9
1027	7016	44	VK2ER	159233	228242	9.5.6	8.3.3	9155	9
1050	7016	47	VK3GQ	159228	999777	9.5.8	9.5.6	9522	9
1059	7016	37	VK3BQ	159999	873242	8.5.7	9.5.5	9522	9
1106	7016	45	VK3JO	159873	595332	9.4.7	9.4.4	9522	9
1121	7016	35	VK3JQ	159595	777987	9.4.6	9.5.6	9522	9
1202	7016	36	VK2XU	159777	514852	9.5.7	9.4.5	9155	9
1234	7016	45	VK2CS	159514	789321	9.5.6	9.5.7	9155	9
1254	7002	23	VK2MY	159789	777242	9.4.6	9.5.5	9155	9
1309	7016	53	VK3KX	159777	276555	8.5.7	9.5.5	9522	9
1320	7002	24	VK4WH	159276	365954	9.4.5	9.4.5	8806	8
10/28									
0710	7002	24	VK3HK	159365	353313	9.4.5	9.4.5	9522	9
0731	7002	38	VK2DA	159353	777678	8.5.6	9.5.5	9155	9
0815	7002	22	VK2ZC	159777	749911	6.5.6	9.5.5	9155	9
0840	7299	106	VK3JJ	159749	555333	8.5.6	9.5.6	9522	9
0850	7299	82	VK3AV	159555	119222	9.5.5	9.5.6	9522	9
0907	7299	71	VK3RJ	159119	123333	7.5.6	9.5.6	9522	9
0936	7299	93	VK2UC	159123	892882	7.4.5	9.5.6	9155	9
1023	7299	96	VK2XV	159882	221852	9.5.6	8.4.3/4	9155	9
1110	7016	28	VK6MN	159221	485555	8.3.4	9.3.3	10890	10
1124	7016	46	VK6RX	159486	244888	5.4.5	9.4.5	9784	9
1150	7016	54	VK4JB	159244	504000	9.3.4	9.4.4	8806	8
1223	7016	31	VK7JB	159504	624321	9.5.8	9.4.6	9532	9

To be multiplied by 6.

1000  
6  
6000

**STATION DESCRIPTION:**

Receiver: FBXA, with preselector added in middle of contest. Receiving antenna was a 66-foot doublet with transposed feeder. The receiver dial settings given above are for the 7 m.c. band spread coil, with 7000 KC about 22 on the dial, 7300 about 123 on the dial.

Transmitter: Tube line-up: 59-59-841-852-p.p.852s. Final plate voltage, 2500. Runs 500 watts in final on 7299, and 600 watts on 7002 and 7016 KC. Transmitting antenna probably not so good for VK as it is east-west, although its 260-foot length makes two lobes swing around to a small angle from wire. This is fed with a single wire about 24 feet from one end. Operating antenna at 4th harmonic

I hereby certify that I have operated during this contest in accordance with the rules laid down, have adhered rigidly to the regulations governing amateur radio in my country, and that the score and points set out above are true and proper.

E. H. CONKLIN, W9FM

Call held jointly with Fred Marco, W9ZA.

Sometimes the VKs were very long in coming back. They might not have heard me sign off, but many were probably looking for several calling them, for more DX. And as I sometimes gave only 4 calls and one or two signs, they were off me when I finished. Thirty seconds might elapse sometimes before they would come back. I gave up VK2BJ to call VK2AZ once, then found 2BJ signing to me a minute later. VK3MR, I believe, worked myself and W9TB at the same time.

The frequencies I used were 7002.2, 7016 and 7299.2, with very slight changes with temperature. Most changes were to a slightly lower frequency.

I had a fine time, was able to get to work without MUCH loss of sleep. No eating meals at the key as in the U. S. contest! Have another next year and I will squirt a beam on you—if a beam is any good at the Antipodes where the signal converges anyway.

**W9FM**

512 N. Main Street  
November 6, 1934

**COMMENTS ON FREQUENCIES OF STATIONS HEARD AND WORKED DURING VK TEST**

There were several VKs around 7000, and I presume that they sometimes had QRM from W1 stations right on top of them. Those from 7015 to 7090 were not much troubled with QRM, and except for several around 7060, the VKs were well scattered. The concentration at 7060 did not seem to cause QRM on the FBXA. There was, however, a very distinct concentration on 7100. VK2CS would sometimes blot out VK6SA, and VK2ER, VK2MT and VK6RX were sometimes QRM'd by other VKs.

From 7110 to the HF end, there were no more concentrations except around 7270 where VK2NY would get buried under VK3HL and VK3JJ. The lack of VKs around 7150 was real, I believe, although I spent less time listening there, due to my experience with the difficulty in raising them. VK2NP was the only one raised between 7140 and 7170. I tried from both ends, but without other success. During the W contest last March, one ZL after a CQ would indicate "tuning HF end" or tuning middle 100 KC" which was a great help. I should like to suggest that we develop perhaps four "Q" signals to mean "tuning from low frequency end," "tuning from middle

towards low frequency end," and similarly for the other end. Then more end-to-end" work could be done with better chances of raising a station called. Those VKs in the middle seemed to have no tuning system unless they tuned over the middle, at least so it would seem from the watts used in calls.

Except for VK2NY, I raised anything up to 100 per cent of stations in the 75 Ks at the HF end. Lots of room there, it seemed, with little W QRM. Possibly the VKs worked them all and then like VK3HK moved closer and closer to the low frequency end. The proposed Q method (above) might make it unnecessary for VKs to move to the other end.

**Australian Stations Heard by W9FM, Wheaton, Illinois**

Week-Ends in October, 1934, Only

Asterisks Indicate QSO

- VK2AE, VK2AS, VK2AZ, VK2BJ\*, VK2BP\*\*, VK2BX, VK2CS\*\*, VK2CY, VK2DA\*\*\*\*, VK2DR, VK2DW, VK2EL, VK2EO\*, VK2ER\*, VK2EV, VK2FD, VK2FM, VK2FO, VK2FX\*\*, VK2IC, VK2HY, VK2KA\*\*, VK2KB, VK2HJ\*\*, VK2MT, VK2MY\*, VK2NP\*, VK2NY, VK2OD\*\*, VK2OF, VK2OJ, VK2PH, VK2PN, VK2PT, VK2QN, VK2QP\*, VK2RG\*, VK2SE, VK2UC\*, VK2UF, VK2UY, VK2VQ\*, VK2WH, VK2WU, VK2WW, VK2XO, VK2XU\*\*\*, VK2XV\*, VK2ZC\*\*\*, VK2ZW.
- VK3AV, VK3BF, VK3BJ\*\*, VK3BW\*, VK3CS\*\*, VK3DM\*, VK3DP, VK3EG\*\*, VK3FG, VK3FJ, VK3GO, VK3GQ\*\*, VK3GU, VK3HG, VK3HK\*\*, VK3HL\*\*, VK3HT, VK3JJ\*\*, VK3JO\*\*, VK3JL, VK3JQ\*\*, VK3JZ, VK3KX\*\*\*\*, VK3ML, VK3MR\*\*, VK3OL, VK3OX\*\*.
- VK3R\*\*, VK3TM, VK3UH, VK3WC, VK3XU\*, VK3YO\*\*.
- VK4BB\*\*, VK4GR, VK4JB\*, VK4JU\*, VK4KG\*, VK4KO, VK4RY\*, VK4US\*\*, VK4UU\*\*.
- VK4WH\*.
- VK5DO, VK5FM\*, VK5JC, VK5LD\*, VK5MD, VK5MK\*, VK5MY\*, VK5RX\*, VK5RT\*, VK5WJ, VK5WP\*, VK5WV, VK5WU.
- VK6MN\*, VK6SA\*\*.
- VK7BJ, VK7JB\*, VK7KJ\*, VK7KU\*, VK7RC\*\*.

73.

Elmer H. Conklin, W9FM\*

\*Jointly with Fred Madco, W9ZA.

**CALLS HEARD**

Calls heard by Fred C. Collins, 1728 N. 59th St., Philadelphia, Pa., from Oct. 18 to Oct. 22.

**14 MC. Band**

W6GS, W6QD, W6ALT, W6AWA, W6BDD, W6BGW, W6BLP, W6CXW, W6DVI, W6FNY, W6GPB, W6JMI, W6KZH, W6LDQ, W6LFL, W7BD, W7JQ, W7VY, W7AFS, W7AYQ, W7BAC, W7EOR, W9LLW, W9RAR, G2NH, G2NP, G2PL, G2WK, G6QB, G6AY, G6HB, F8KJ, F8RQ, F8RU, F8XU, VE1AH, VE1VF, VE1GI, VE3VA, VE4AE, VE4OX, VE4TO, VE4TV, VE4WT, VE5HR, K5AA, NY1AB, HJ3AJH, ON4CSL, CX2AM, HB9AQ, X1AY, X1AG, VP4TC, LU6AP, LU5DJ, LU2AM, I1MD, PY1IF, PY2QB, D4BER, HC2MO, EA3AG, CM2WA.

**14 MC. Fone**

W6AHP, W6CNE, W4UP, W5FC, W5AEB, W5BDB, W5CCB, W9JI, W9LD, W9BHT, W9LCE, CM2QY, CM2RA, CM2WZ, CM6XS, H16X, LA1G.

•••

Stations heard and worked by W8DVS, 1414 Beaver Road, Ambridge, Pennsylvania, on 14 MC during 23 different days of operating between September 23rd and November 4th.

CM8LC, CX1FB, CX2AM, EA6AG\*, ESX5X\*, FB8C\*, EZ4SAB\*, FC4CJJ, G2II, G12KR, HAF2D, HC11JW, HC2MO, HJ3AJH, HK1XA, L11Y, L1MD, K4KD, J2GX, J2HG (QSO?), LA3C\*, LU1EP, LU1FH\*, LU2AM, LU3FC\*, LU3DE, LU3OA, LU4DQ\*, LU5BC, LU6DJ, LU6ER, LU7BH, LUFEE, LU9AF, LU9DW\*, OE3FL, OH3NU\*, ON4CSL, OZ2RS\*, OZ7KZ\*, OZ9S\*, P3IC, PY1AW, PY1IF, PY2BU, PY3AN, PY3AS\*, PY9AM, SM5TC\*, SM7XQ\*, SX3A\*, U1AN\*, U3DI\*, V1UU\*, VK2GC\*, VK3MR, VK4BB\*, VQ4CRL, VQ4CRO, VQ4KTA, XOH2FJ, XOH3NQ, XZLN2B, YL2BB, ZE1JF, ZS1H, ZS1P, ZS2A\*, ZS2N, ZS4U, Z11Z, ZT2F, ZU6P.

Power here is 1 210 final in xtal, 125 watts. Asterisk \* indicates stations called but not worked.

•••

**Calls Heard by W1FET, Stoneham, Mass.**

June to October

**14 MC.**

CM6DW, CM2TT, CN8MP, CP1GB, CX2AM, CX1CG, CX1FB, FC4CJJ, FM8BG, FM8DA, FM8IH, FM4AA, HC1FG, HC1PZ, HC2JM, HC5X, HI7G, H18X, HJAW, HJ3AJH, HJ5ABG, HK1XA, J2GX, K5AA, K5AF, K5AZ, K4ZK, K4KD, K6BAZ, K6CQG, K6EDH, K6GQF, K61DK, K6JJP, K6KPP, K6KVX, KN3, LU1CA, LU1CH, LU1EP, LU3DE, LU3DD, LU3DH, LU3OA, LU6DG, LU6ER, LU8DR, LU9AH, LU9BV, LU9DT, LU6DJK, LY1J, NY1AB, NY2AB, ON4CSL, PY1AW, PY1BO, PY1CH, PY1IF, PY2BK, PY2BU, PY2BZ, PY2CB, PY2CD, PY2IB, PY2QA, PY3AN, PY6AD, PY9AM, SU1CH, SU1EC, SU1MO, SU1SG, SU1SJ, SU2NP, SU3AB, SU3EH, T12FG, T12TAO, T13WD, U1BW, U1NP, U3BH, U3VC, U6AQ, VK2LZ, VK2UF, VK2XU, VK3MX, VK7KV, V08H, V08Z, VP2BX, VP2CD, VP2RT, VP4CF, VP4JZ, VP4TC, VP6AB, VP6JB, VP6NH, VP6SR, VP6ST, VQ4CRO, VQ4CRL, VQ4CRP, VQ8A, W10XDA, X1AA, X1AY, X1AM, X1CM, XQ2L, XU3FU, X11X, XZ4F, XZLN2C, XZLN2J, ZC6FF, ZL1GX, ZS1P.

VQ8A on 14 MC gives his QRA as Ascension Island. His frequency is approximately 14300 KC, with T7 note. He comes through here from 1900 to 2030 GMT, with signal strength from R3 to R5.

FC4CJJ gives his QRA as Belgian Congo. Frequency about 14350 KC, with T7/T8 signal. His signals are heard between 1900 and 2100 GMT.

XU3FU was the call used by the Russian icebreaker Krassin, who gave his QRA as at Wrangell Island in the Arctic Sea.

**7 MC—September and October**

CM2FA, CM8FO, CM8PZ, CT1AZ, CT1ED, CT1ZZ, D4BAR, D4BBN, D4BEH, D4BKN, D4BNN, EA1AE, EA3BY, EA3CY, EA3EG, EA4AY, EA5BC, EA7AO, EA7BC, EA7BE, EA8AF, EA8AH, EZ4SAZ, FM3JZ, FM8BG, FM8CR, FM8FD, HAF3D, HC2AG, HJ3ABH, I1P, I1UL, I1XX, K5AG, K5AM, K4CVV, K61BW, NY1AB, NY2AB, OE7EJ, OE7SH, OK1FD, OK1FK, OK1LN, ON4MR, OZ8D, U8AE, VE5DR, VE5GL, VE5HC, VE5HQ, VE5HU, VE5JC, VK2DA, VK2EO, VK2MT, VK2NY, VK2QP, VK2XC, VK2YL, VK3KX (long way around), VK3YO, VK4KO, VK4WD, VK5MZ, V08Y, VP4AA, VP6MK, VP6PA, VP9H, X1BC, X1CT, X1N, X1W, X3G, XK2FL, XZLN2B, XZLN2O, YR5AA, ZL1BY, ZL4FE, ZS2A, ZS2X, ZS6AM, SXA3, SFRA.

Conditions as a whole have not been very good on 7 MC, especially during the latter part of October.

Here Are a Few Stations Heard on 3.5 MC  
W6AOZ, W6IPK, W7AAX, W7ASX, W7BNU.



This month The Interceptor has intercepted a letter from Louis R. Huber, ex-Alaskan radio amateur who played a personal part in numerous radio rescues. Huber's amateur career has been packed with thrills. Here's one of them!

★ ★ ★ ★

It was only a little transmitter. Used a 210 in the Hartley circuit. Nothing to brag about, only it worked. Simplest sort of a rig in the whole wide world of transmitters. A laboratory expert might have passed over it with a smile if it were placed in a row with bigger, more "modern" transmitters.

Not that it was built shabbily, or carelessly, for it wasn't. Jack told me it was the last one of a series he built experimentally, six other Hartleys having been ruled off in favor of this one. It didn't use crystal control, but short, sturdy leads and good construction compensated for that, and the wave-changing feature of self-excited transmitters was thereby retained.

The really remarkable feature of the thing was what it did, rather than what it was. I don't think Jack had any vision of what it was going to do when he packed it aboard the cannery tender in San Francisco in 1931 and took it to Ugashik, Alaska — for his own amusement more than anything else—during the salmon season of that year. Landing on the shores of Bristol Bay, he matter-of-factly put up a 66-foot aerial and got on the air in the amateur 40-meter band. For Jack Anderson, you see, was a radio amateur long before he became a commercial radio operator—and his call is W6ACV, San Jose, California.

When he got on the air in Ugashik, W6BHY in his home town was looking for him. They arranged a nightly schedule. It worked out nicely—news from the home folks every evening. He told people in Ugashik about it. They didn't seem to be impressed. (As a matter of fact, they didn't believe him. Just another of those tall stories the Outsiders were always telling, they thought!)

But there was one man who took a chance on it. He was Vincent Rucello, an Italian fisherman, whose home was in Monterey, California. One evening he showed up at the wireless shack.

"Meesta Operator . . . he began.

"Just call me Jack," was the answer of the supple young man wearing headphones and motioning Vincent to a chair. "What can I do for you?"

"Well, I gotta the sick wife, you see. She's a down in Monterey an' I no tell how she get along. I gotta no dough for send message . . . but I hear you maybe send-a one free?"

"Why, sure, I have a schedule with San Jose at 8 o'clock and if you'll write out your message I can send it for you then."

Vincent was back a day or so later to get his answer. Mrs. Rucello was improving and, as the days passed, she continued to im-

prove. Vincent's reliance on Jack and the little Hartley transmitter was steadfast.

"Message for Mr. Rucello!" Jack would announce pompously to Vincent as he appeared at the shack after a hard day's tussle with nets out on the bay. Handing the message to him, Jack would watch the happy smile soften the features of the faithful Italian.

"Oh, she's a-gettin' along fine, Jack. Thanks a whole lot. When we get back home, maybe I make-a some wine, special for you!"

The population of Ugashik soon learned that Jack was not joking when he said he talked nightly to San Jose, and Seattle, and other places. Gradually they began coming to him, wanting to send messages to friends and kin—messages they could not afford to send by commercial means.

And by the end of the canning season, when Jack was to leave with the rest of the cannery crew, he was more than just "the wireless operator for the P-A-F." The strange intricacies of fate had placed in his hands the power of serving his fellow men in a way in which they could not serve themselves—and Jack Anderson, K7BCJ (for these were

of potatoes. You are proud of them, they are yours by right of your own labor, you can eat them yourself or sell them or even throw them away, but what fun to give some of them away!

And so when the canning season was over, Jack didn't take the Hartley home. He left it with the government school teacher, S. C. Hanson, and his son, Virgil Hanson. Then the little Hartley began to prove its mettle. Radio was new to the Hansons, but they finally got the set installed according to Jack's directions, and the very first use to which it was put was the calling of aid for a fever-stricken village.\*

When the transmitter was installed by the Hansons it became K7BOE and was soon a regularly heard station up and down the Pacific Coast. Usually Virgil did the operating, although his father was equally skilled at the key. What a thrill for them to know that signals from their little set hopped right over the ocean, over the hills and mountains of that bleak country and found their way to civilization! Hardly could they believe that what had been cold, messageless winters before, would no longer be silent. Ugashik had a voice.

Mr. Hanson was indulging in a reverie along this theme one snappy evening in November, when a heavy knock resounded on the paneling of the door. It was a native Aleut clad in furs, and bringing a whisk of the North wind into the room with him. Evidently he had been on the trail for some time, for circles showed dark under his eyes. He lost no time in explaining.

"I start from Egegik yesterday. Been mushing all time. Teacher Bergman, he very sick. He say got acute appendicitis, and come tell you quick. Woman there also very sick, and Bergman say both must get took out by plane."

Mr. Hanson looked at Virgil, and both understood.

"Yes," said Mr. Hanson to Virgil, "get hold of somebody—Hal Noggle in Anchorage if you can—and have a plane sent to Egegik right away to take Bergman and that woman to the hospital."

The plane was called, and today two residents of Alaska are alive and healthy who undoubtedly would have died had there been no amateur radio at Ugashik.

It was not long after this that Johnny Powers, a native, went violently crazy and menaced the whole village. Again the little Hartley stepped in. The deputy U. S. Marshal from Naknek was summoned and came with a plane to take Johnny to that third "side" of Alaska—Morningside.

Ugashik is situated on the south shore of Bristol Bay, that part of the Bering Sea from which, of all Alaska, the best—and the most—red salmon are caught. Like all Alaskan villages owing their existence to the salmon industry, it is built almost on the beach, just a few feet above high-tide line. Ordinarily this is safe enough, but the architects of Ugashik didn't count on the high January tide of the year in which Jack Anderson gave the Hartley to the Hansons.

This tide, it happened, was pushed by a stiff offshore breeze and, what's more, it had cakes of ice in it. The result was that half the village was smashed up, the refugees taking to hastily-erected shelters on the low hill at Pilot Point, Ugashik. Fortunately the residence of the Hansons was just out of reach of the sea, and escaped with its porch piled full of ice. K7BOE, as one might expect, went on the air and called in aid for the homeless population of the little village.

With all these achievements to its credit, the little Hartley had a perfect right to expect a rest. It got one. The Hansons liked the operation of this little transmitter so well

(Continued on page 34)

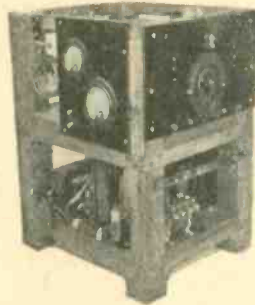

"Just a Low Power Rig"  
Above—Front and Side View.  
Below—Plan View of the RF Portion

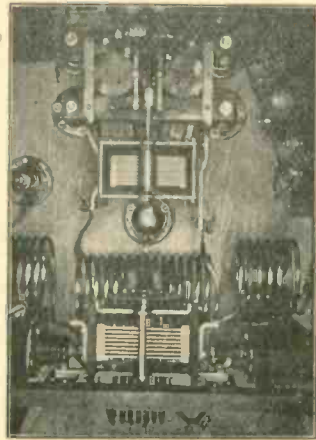

the call letters of the little Hartley), became Public Benefactor No. 1 of Ugashik.

It is doubtful that Jack thought much about it. He knew, of course, that the messages he handled, if charged for at commercial rates, would have cost about 20 cents a word. It would have netted him a nice little profit if he could have charged one-half that much. But Jack was not in business, and business had never entered his head when he built the little Hartley transmitter. It did not enter his head when he realized the great service he was doing the people of Ugashik, either, because he had a better reward than money.

One exults in his kind of achievement—covering thousands of miles in an instant just through your own handiwork—and exultation is catching. You like to give it away to your friends. So did Jack.

There is nothing more satisfying in the range of human emotion than generosity. You plant a garden and raise—let us say—a bushel



# QUARTZ CRYSTALS AND THEIR APPLICATIONS

## INCREASING CRYSTAL EFFICIENCY

By GEORGE B. HART

A CRYSTAL is only as efficient in a circuit as its holder permits it to be. As a result the market has been deluged with various so-called "low-loss" crystal holders. But I believe it was George Parsons of Berkeley, California, who first conceived the idea of silvering the surfaces of the crystal with a resulting increased efficiency due to the excellent contact between the crystal and the silvered surfaces as well as the extremely thin and light surfaces resulting. Consequently the crystal is obliged to do very little mechanical work in vibrating.

When the crystal is placed in the conventional holder consisting of two polished brass plates and permitted to oscillate freely, it will be found that it gives as much power output as before silvering. But if the silvered crystal is removed from the holder and connected to the circuit by two small wires pressed lightly against the silver surfaces of the crystal it will be found that the crystal oscillates even more freely and with much greater output than when used in the conventional holder.

Experiments with a number of cheap crystals, some of which would not even oscillate under normal operating conditions, showed conclusively that a crystal silvered by the Brashear method would oscillate much more efficiently than when unsilvered and operated in a conventional holder.

The actual method of applying the silver is very simple; wash the crystal with carbon-tetrachloride to free it from grease and dirt. Then place it in distilled water until the silvering solutions employed to complete the job have been prepared. Two such solutions are used, the first consists of 1 gram of silver nitrate dissolved in 150 c.c. of distilled water and a dilute solution of ammonia, until the brown precipitate is nearly, but not quite, dissolved. Add one-half gram of potassium hydroxide which has been dissolved in 25 c.c. of distilled water to this solution. The solution will then turn a dark brown in color and ammonia should be added until this second precipitate is nearly dissolved. DO NOT add enough ammonia to make the solution clear. Now place the crystal on edge in a clean tea cup or other deep dish. A deep receptacle should be used so that the crystal may be leaned against the edge enabling the solution to come in contact with both sides of the crystal. The solution is now poured over the crystal and into the receptacle very carefully in order to prevent the crystal from falling flat.

A reducing solution consisting of 8 grams of cane sugar dissolved in 70 c.c. of distilled water to which has been added 18 c.c. of ethyl alcohol and 0.3 c.c. of concentrated nitric acid dissolved in 15 c.c. of distilled water should now be prepared. This solution should be allowed to stand about ten days before using. When it is ready to use, add about

15 c.c. of the reducing solution to the first solution and allow the combined solutions to stand for four or five minutes. After about five minutes a brownish grey film collects on the surface of the solution. The liquid may then be poured off and the crystal washed in distilled water and dried.

Now that the crystal is dry, polish the edges with fine carborundum in order to prevent contact between the two opposite silver faces.

To complete the holder and permit practical operation we employ a simple grip consisting of two thin, high tension brass strips bent to grip the crystal as it is slid between them. Over this is placed a very small jelly glass to protect the crystal from accumulations of dust.

## FLATLY GROUND PLATES FOR THE CRYSTAL MOUNTING

By ALBERT F. HOEFLICH

THERE is a saying: "A poor crystal must use a holder with absolutely flat electrodes, while a good crystal will oscillate on a file". This is only relatively true, because well-ground electrodes will help in obtaining maximum kick from any crystal. The writer prefers polished electrodes in his crystal holders. These are easier to clean and keep clean, because the pores which are usually present in unpolished flat-ground electrodes and which tend to absorb grease and dirt, are absent in polished electrodes.

To test your electrodes for flatness, press them together firmly, then lift the top one. The bottom one should cohere for a few seconds before dropping off. If the two do not stick together under this test, some improvement is usually possible.

### Making Flat Electrodes

MIX a quantity of 3F carborundum grain and water to the consistency of a paste and spread upon a piece of plate glass. Place the plate to be ground face downward on the mixture and grind by rotating in circles on the glass. Continue this operation until the plate shows an even, flat color. Then spread several thicknesses of newspaper on the table and place a small quantity of the grinding mixture on the paper. See that the mixture is dry and make sure that the plate has also been wiped dry. Now dry-polish the plate by rotating it face downward on the paper.

Proceed in like manner with the other electrode. When the two are finished, rub them together and inspect the surfaces for non-flatness by observing the portions which do not scratch when the two are rubbed together. To approach an approximate flat, continue rubbing the two plates until the two surfaces are evenly colored. Then repolish.

This method will give a fairly flat surface. If a more exactly flat surface is wanted, proceed as follows: Start with three plates. Grind until evenly colored, using the plate glass and abrasive method. Then number the plates 1, 2, and 3. Now, using the abrasive from the

glass, grind No. 1 on No. 2; No. 2 on No. 3, and No. 3 on No. 1. Continue this until the plates show an even color all over, or until they will adhere when pressed together (dry).

If the plates are polished frequently during this process by taking a few "swipes" with each one on the "dry polisher", the progress of the grinding will be easily observed. Finish the job by dry-polishing the plates.

## New Products from The Manufacturers

HERE is an example of beauty and efficiency.

Heretofore the goal of most one and two tube set builders has been efficiency and performance. Beauty did not count so long as the set could bring in elusive, distant stations. ICA engineers developed the Universal Mascot—1, here illustrated.

A glance will be sufficient to justify the claim that here is an eye-filling one tube Short Wave Receiver. It is an excellent example of compact, yet efficient design. The circuit used in this receiver is shown in the accompanying diagram and it is designed for use of a 30 type 2 volt battery tube.

One of the factors of this 1-tube set is that not only are the 4 short wave bands from 16 to 217

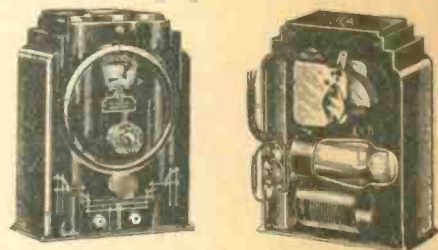

Exterior and Interior Views of novel new I.C.A. "Mascot" one-tube S.W. Receiver

meters covered by four plug-in coils, but for those desiring it there is also available a short-wave coil covering the band from 9 1/4 to 21 meters.

The owner of a 1-tube set will frequently want to listen to the regular broadcast channels between 190 and 550 meters. To satisfy this requirement, the manufacturers have also made available at a nominal cost extra broadcast band plug-in coils. The first coil covers the band between 190 and 310 meters while the second coil covers the band between 300 and 500 meters.

The entire set including the tuning coil and the tube is housed in a bakelite case. The size overall is smaller than most midget sets.

Phone tip jacks are mounted on the front panel

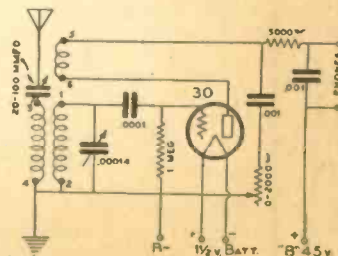

Circuit Diagram of the Compact I.C.A. one-tube "Mascot"

which is made of metal so as to eliminate any body capacity detuning effects.

The set is supplied in kit form, comes complete with easy-to-follow instructions and wiring diagram and can be assembled by the inexperienced novice.



# 3/4-Meter Transceiver

By FRANK C. JONES

## Editor's Note:

● For several years there has been a standing offer of a \$50 cash prize, posted by Mr. Ralph M. Heintz, president of Heintz & Kaufman, Ltd., for the first practical and successful two-way 3/4-meter installation. The prize was captured by Frank C. Jones at the recent Pacific Amateur Convention.

**T**WO 3/4-meter transceivers similar to the one shown in the illustration were used to demonstrate amateur phone communication on the micro-waves at the recent amateur convention at Fresno, California. Successful two-way communication was obtained over short distances, but it is hoped that distances of several miles will soon be covered on the micro-waves.

The circuits shown are not the ultimate in design, by any stretch of the imagination. However, the sets worked satisfactorily, both

and between the two director wires was used. This amounted to about 10 1/2-in. spacing. This antenna was not very directional because there were no reflector wires on either side of the antenna and a great many more director wires should have been used. By using really-good directional antenna systems, the apparent low power of the transmitters can be increased so that it should be possible to communicate over air line distances of several miles.

The RCA 955 tube is inclined to be microphonic and it also has a tendency to "run away", similar to the action which takes place with an overloaded type 46 tube. It is necessary to keep the plate and grid currents within the limits recommended by the tube manufacturer. One way to prevent the tube from creeping-up in plate current is to use cathode bias and a fairly low value of grid

10 or 15 turns causes trouble. This is probably due to the high RF impedance of the path back to the nodal point of the tube and LC circuit. It is difficult to by-pass effectively at these frequencies and thus a few experiments with RF choke turns, location of leads and chokes, and contact resistance of the tube clips will remedy this source of trouble. Oscillation should always be checked by means of a plate circuit milliammeter. The plate current should never exceed about 7 milliamperes on the transmit position, if one expects more than a few minutes of tube life. This at least holds true from the writer's experience.

The oscillating circuit consists of the tube capacities and a parallel wire LC circuit. At 3/4 meters the parallel wire length is slightly

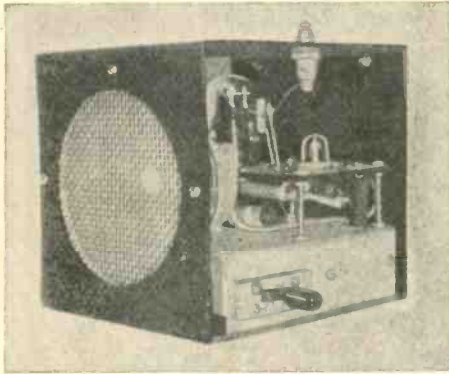

The 3/4-Meter Transceiver in metal case. A midget loud speaker is built-in. The RCA-955 "Acorn" tube is plainly visible.

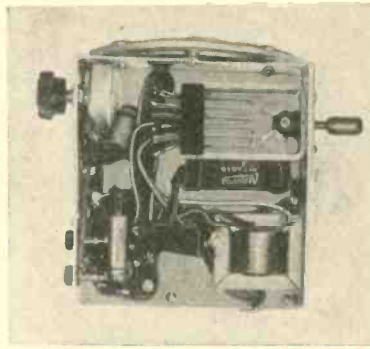

Under-chassis view, showing correct location for mounting the 4PDT anti-capacity switch and the output transformer.

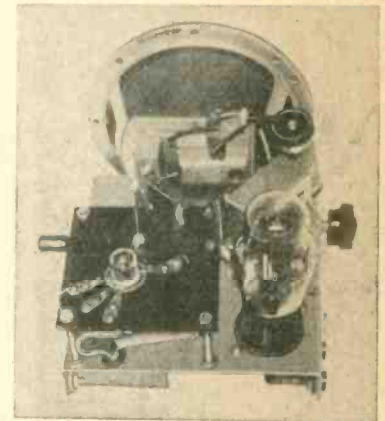

Showing how the RCA-955 "Acorn" tube is mounted on a Bakelite sub-base which is isolated from the metal chassis deck.

as transmitters and receivers. Undoubtedly much more output for a given input can be obtained if the grid excitation could be adjusted properly, such as by the use of a semi-variable grid condenser and proper location of that condenser in the LC circuit. W6CLH reports much greater output by means of these adjustments.

In the circuit shown, the similarity to the usual 5 meter transceiver is quite apparent. The transmitting oscillator is modulated by a type 41 tube with a single-button mike input. On the receive position, the oscillator becomes a blocking grid-leak type of super-regenerative detector, and the 41 modulator tube becomes an audio amplifier driving a small magnetic loudspeaker to moderate volume on fairly-strong signals. The switching circuit is similar to that used in most 5 meter transceivers. It changes the grid-leak value so as to obtain either ordinary oscillation or super-regeneration. It also switches the input and output circuits of the audio tube and turns on or off the microphone current and heater circuits.

The new RCA type 955 "acorn" tube was used because its extremely small elements and capacities allow it to function satisfactorily on wavelengths below one meter. Its power output is quite low as an oscillator and thus a beam antenna should be used. The antennas used for the first tests with these sets consisted of short lengths of No. 10 wire, thrust through tight-fitting holes along a 3/8-inch diameter wooden dowel rod. The antenna was a wire 13 3/4-in. long with a reflector 14 1/4-in. long and two directors 13-in. long. The antenna wire was spaced a quarter-wave ahead of the reflector wire, which amounted to about 7-in. 3/8 of a wavelength spacing between the antenna and director

leak. Then as the plate current starts to climb, the grid bias increases and tends to reduce the plate current. The use of this method seems to solve the problem of tube life.

To obtain oscillation in these particular sets, it was necessary to use a cathode RF choke. The 450 ohm cathode resistor prevented super-regeneration until it was bypassed with a .01 mfd. condenser. This condenser by-passes the super-regenerative hiss frequency, although it would probably have been equally satisfactory to return the plate by-pass .01 mfd. condenser to the lower end of the cathode RF choke instead of to ground. The number of turns in the RF chokes seem to be somewhat critical. A variation of from

over an inch in length and is made by soldering a pair of No. 14 bare copper wires to the tube grid and plate clips. The parallel wire bridge consists of the .0001 grid condenser.

Antenna coupling can be accomplished by connecting the antenna feeder to some point along the parallel wires, or preferably by inductive coupling. The usual two-wire feeder would undoubtedly be better than the single-wire feeder used in these first tests. The latter was connected to the antenna 2 inches off center. A two-wire feeder can be made of No. 24 or 26 wire, spaced about an inch and tapped across the center of the antenna in the usual Y connection. The Y

(Continued on page 36)

## 3/4-Meter Circuit

The RF Choke consists of about 25 turns of No. 22 DSC wire, wound on a 1/4-inch diameter form. T1 and T2 are Output transformers. Those used in the Transceiver here shown are of the 2A5 P.P. Output type. Although the circuit diagram shows a number of separate switches, for the sake of simplicity, a 4-pole-double-throw switch will serve the same purpose.

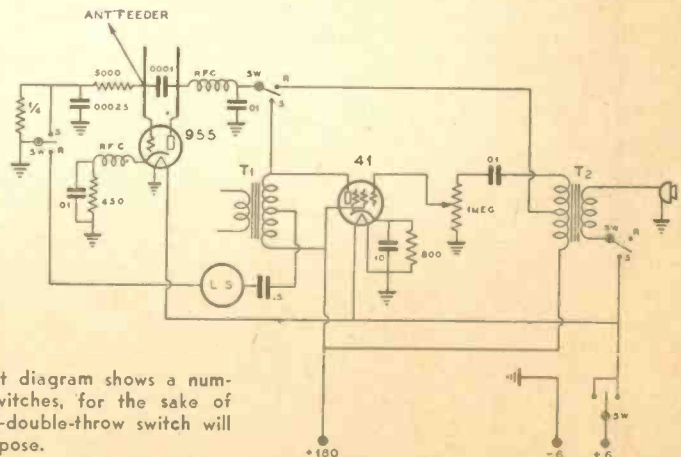



## McMURDO-SILVER

### • • Just to Talk With You

I'M buying this space just to talk to you, since I can only do it personally with a very few of you. Because I've got a lot on my mind this time, here goes, with more details later.

Some ten years ago I think I introduced into radio the free trial guarantee—was the first maker with sufficient confidence, not just ballyhoo, to say simply, "try it, if you don't like it bring it back and get your money."

Practically any radio so offered *has* to be good for you to keep it after the first thrill of dial twisting is over. I sell broadcast receivers on that basis, and I'm going to sell amateurs on that basis. My experience tells me that's what you want, and I know I'm going to get mighty few sets back once you've operated them. So here goes.

You can get the 5C or the MASTERPIECE III-X, tune it ten days, and if you don't like it, ship it back in undamaged condition and you'll get your money back right away. Any jobber who knows his onions will give you the same deal—but, if he won't, I will.

Back last summer I phoned Dr. Weeks of Raytheon and begged for a ten watt r.f. pentode. It'll soon be along—the new Raytheon RK-23. It's the ideal crystal or E.C. oscillator and buffer all in one tube, like the RK-20. It will operate straight through on fundamental frequency, unlike the poorly screened '59s and 2A5s you've been using in tritets. And it should be plenty cheap.

While speaking of r.f. pentodes, I want to apologize if our advertising has caused anybody to mis-rate our 10D transmitter. It turns out 100 to 130 watts C.W. on crystal fundamental, about 50 to 60 watts on crystal second harmonic. Naturally on phone with an RK-20 its peak output is the same, while its average carrier is one-quarter this—we rate it at 25 watts phone carrier power. And RK-20's won't parallel as tritets.

Incidentally, RK-20 output ratings are a joke. We regularly get 100 to 130 watts out of one tritet fashion, at 1200 to 1300 volts, plate and *rated* plate dissipation. Raytheon being awfully conservative, probably won't re-rate it, but they tell me that I've proven it, that the RK-20 is good for 190 watts output at 2000 volts plate and 240 watts at 3000 volts all at normal safe plate dissipation. But such outputs, while almost perpetual motion in terms of efficiency, require much care and plenty of battery bias to prevent burn-up if excitation fails. But the RK-20 really should be rated at 100 watts—it turns it out safely and sweetly at safe voltage and dissipation, while its top-plate-lead insulation will stand plenty. But then, you all know amplifier or oscillator efficiency goes up fast with increased plate voltage—and care.

If you want power *safely* out of a crystal, the RK-20 is it—100 watts with no more strain than a 47 tube on your pet crystal.

And the new dual crystal filter. If you're a phone man, it's really the real McCoy. If you're C.W., one crystal is enough in the filter.

If what I've said above amuses or interests you, won't you drop me a card, and I'll get mad and buy another page for ramblings. Tnx-cul.

McMurdo Silver

# The MASTERPIECE III-X . . . .. Is As Revolutionary As the Single Signal

You know what single signal code selectivity is, and of course the MASTERPIECE III-X has this selectivity, although it and the 5C are the only receivers made today that don't sacrifice one iota of sensitivity to get this super-selectivity—you don't lose half an R for its crystal code selectivity. But—it has the new Silver dual crystal circuit that chops out of the air exactly one phone signal at a time, and no more—that eliminates heterodynes within one kc. of the station you want. This is made possible not by the old useless "parallel crystal" scheme that made you wonder what it was ever included in receivers at all for. Not at all! Two crystals 700 cycles apart are used, one alone for code, both in parallel for phone. Thus you get a one kc. wide band, which gets intelligible speech, sans noise, sans heterodynes, sans interference as has never before been possible.

And when you want high quality broadcast, turn the crystal switch and you've got the world's finest broadcast receiver—the receiver that has elicited more enthusiastic praise from experts than all other radios put together have ever received—even good words.



The MASTERPIECE III-X in the opinion of those who have used it in action, is the supreme receiver of all types. For it alone combines without reservation or sacrifice the unequalled and spectacular broadcast performance on all waves of the internationally famous MASTERPIECE III, with the unequalled completeness and flexibility of the 5C, plus the new dual crystal phone selectivity that competitors will begin copying the day they read this ad.

Whatever it is you want, the MASTERPIECE III-X has it. One tuned r.f. stage so good it puts other two-r.f. supers to shame. Three air tuned i.f. stages. Perfect automatic volume control as found in no other receiver in the world—or cut out at the throw of a switch. Separate audio volume and r.f. sensitivity controls. Selectivity anything you want it to be when you want it. Tone quality that out high fidelity's high fidelity. Beauty, ruggedness, ease of operation, band spread anywhere in the range by the originator of "one dial band spread." Briefly, it has every feature found in other sets copied from it by other makers, plus dual crystal filter for real, serious, phone work. Yet it's as low in price as competition that won't even equal the 5C!

## THE 5-C IS TAKING AMATEUR RADIO BY STORM

The 5C is going into more amateur stations today than are practically all other receivers put together! But the answer is simply that it has everything. Name almost any feature you desire and the 5C has it. That's why its predecessor caused W9USA to junk the competitive receivers the World's Fair used in 1933 and get Silver's for 1934. And ask anybody that operated W9USA how they worked!

The 5C is built by a maker who believes in giving, and knows how to give, amateurs full value for their hard earned dollars. It has every feature of sets selling at twice its price, is easy to handle, and has the exclusive and only crystal filter circuit that gives no loss of signal strength in series operation.

This alone would deservedly make it the most popular of amateur receivers and if you don't think it's popular, just ask the QSO's who give you an R9 report what they're using and you'll probably find it's the 5C.

If you want technical dope, it's yours for a postcard—or a look at a back issue of "RADIO" or R/9. But whatever you ask "has it—," the answer is "yes." Tuned r.f., AVC that IS AVC, super-efficient crystal filter, band spread anywhere in its range of 1500 to 23,000 kc., right on the main accurately calibrated, easy to read airplane dial. But why go on—just ask your QSO's! They'll give you the lowdown.

Despite all this, the 5C is priced down where it and its competition belong. Just \$74.70 net with Raytheon tubes and Jensen speaker, or \$83.70 complete with specially aligned Xtal filter that is an Xtal filter.



Get it from your jobber, or order direct—you can return it to us within ten days for full refund if you don't think it's a world beater. Oh yes—what other maker dares offer you receivers on such a trial basis?

**McMURDO SILVER, Inc.**  
3362 NORTH PAULINA STREET CHICAGO, U. S. A.

## THE 10-F 100 WATT PROFESSIONAL PHONE C-W TRANSMITTER

The type 10F transmitter is the improved and "prettied up" model of the now famous 10D. It is the amateur's dream come true. It provides 100 watts of crystal controlled r.f. power on crystal fundamental in any amateur band, and 60 watts on second crystal harmonic. Its phone carrier output is 25 watts modulated 100% with high fidelity broadcast station modulation, all at a cost below what you can build it for!

It employs one RK-20 screen grid r.f. pentode as a crystal controlled Tritet (electron coupled) oscillator. Modulation is affected by suppressor grid voltage variation, which is obtained from a simple two-stage audio modulator.

But read its specifications, look at its price, and get on the air with 25 watts of broadcast station voice quality or 100 watts C.W. cheaper than you can build a 100 watt telegraph transmitter alone! Order it from your dealer or direct and join the P.W.A.C. Club (Phone Worked All Countries)! If you don't believe it, ask anybody working one, W9NKH has obtained R9 phone reports out of every district—W9DDE gets R9-QSA5 phone out of every district on one installed in Waukegan, Illinois.

### SPECIFICATIONS

**R. F. Output:** 100 watts on fundamental crystal frequency. 60 watts on crystal second harmonic. Phone carrier 25 and 15 watts respectively.

**Frequency Range:** 10, 20, 40, 80 or 160 meter amateur bands. Complete coverage with one set low loss tapped coils included.

**Tubes Needed:** 1-RK20 Oscillator, 1-RK19 Rectifier, 1-'57 Voltage Amplifier, 1-2A5 Power Amplifier, 1-80 Rectifier.

**Modulation:** Linear suppressor grid modulation variable from zero to over 100% at will. Harmonic distortion less than 5% at 100% modulation.

**Audio Frequency Range:** Modulation curve flat to 4 db. from 40 to 8000 cycles. Variable tone control provided for high audio frequency attenuation as desired.

**A. C. Modulation Hum:** Negligible.

**Phone-Telegraph Selection:** Two position toggle switch on r.f. unit selects phone or C.W. telegraph position at will.

**Antenna Tuning:** Impedance matching network with two Cardwell 365 mmf. condensers and tapped coil. Will feed any antenna.

**Meters:** None provided except on special order (mounted on r.f. unit panel). One 0-200 ma. milliammeter and, if desired, one 0-2 antenna thermometer are all required to check operation.

**Controls:** Oscillator plate, r.f. plate and two antenna tuning dials. Phone-Telegraph, send-receive, modulator on-off and power on-off switches. Screen and plate current measuring and key jacks.

**Size:** Total height of all three 19x1/18" black crystalline steel relay rack panels 19 1/4". Supplied complete on crystalline black table rack frames.

**Power Required:** 350 watts at 105 to 125 volts, 50 to 60 cycle A.C.

**Accessories Needed:** One Biley crystal and holder, one crystal microphone, and tubes as above.

**Price Net to Amateurs, \$119.70**  
Five Raytheon tubes, price \$25.23 net. Turner crystal microphone and cord. Net price to amateurs \$12.60.

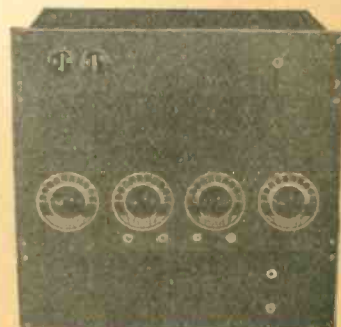

## A New Universal Transmitting Inductance

HERE is a new idea in transmitting equipment developed in the engineering laboratories of Thordarson Electric Mfg. Co.

This Universal Transmitting Inductance offers a single unit to cover all amateur and commercial transmitting bands from 20 to 160 meters.

No longer are separate coils necessary for each band on which it is desired to operate the transmitter.

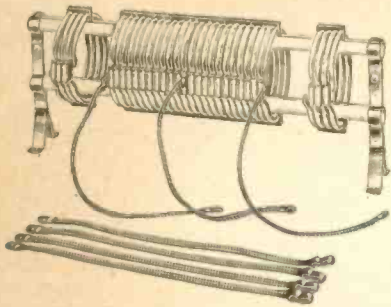

The unit is a helically wound coil of copper tubing 1/2 inches in diameter, each turn of which is joined to the succeeding turn by means of a specially developed removable clip. Thus as many turns may be utilized as are needed for transmission on any given frequency. The table below gives the frequency ranges of units with standard transmitting condenser capacities.

Band	Tank Cir. Turns	Ant. Cir. Turns	Type No.	KC Freq.	Mmfd. Cap.	KC Freq.	Tank Cap.	Mmfd. Rec. Cond. Value
80 Meters	24	8	T-7053	3500	86	4000	65	100
	20	8	T-7053	3500	110	4000	80	125
	16	8	T-7053	3500	140	4000	110	150
40 Meters	12	8	T-7052	7300	40	7000	45	50
	8	8	T-7052	7300	57	7000	65	70
20 Meters	4	8	T-7051	14400	31	14000	33	35
150 Meters	24	8	T-7053	2000	260	1715	350	350

It is seen that a single Universal Transmitting Inductance replaces a set of several of the usual coupling coils.

Each Universal Transmitting Inductance is composed of a number of four-turn coil units that are variable in one-turn steps. Each coil joins the adjacent coil by means of removable clip in the same manner as the individual turns are connected, any number of coils thus forming a single uniform inductance.

### Technical Data

The size of the turns has been chosen so the inductance per turn is approximately one microhenry, thus greatly simplifying computation of circuit constants. Actual measurements of inductances are as follows:

Turns	Microhenries
4	4
8	8.5
12	12
16	15
20	20
24	25
28	30

AC resistance 28 turns at 1000 c.p.s. is 0.23 ohm. The unit may be adjusted for high C or low C circuits, either single ended or push-pull. The tuning condenser can also be tapped across a portion of the coil to give band-spreading.

Contact resistance of the clips is extremely low, being but .023 ohm at 1000 cycles for a complete 28-turn coil, including the clips for leads at both ends. Thus, undue heating is prevented, as is often the case when battery clips are used on ordinary coils. All turns not in use are open-circuited by removing the clips, further reducing any possibility of losses.

## Screen Grid Transmitting Tubes As Linear Amplifiers

SEVERAL hams have commented on the fact that screen grid tubes give very erratic results when used as class B linear amplifiers. One reason for this is that few hams seem familiar with the fact that "cut-off bias" for a screen grid tube is not calculated as it is for a triode. When we wish to calculate "cut-off" bias for a triode, we divide the plate voltage by the amplification factor and then add perhaps 10% for luck. For a screen grid tube, we divide the screen voltage by the amplification factor of the triode, whose elements consist of the control grid, filament and SCREEN GRID. For example, let us consider the 860, operating as a class B linear amplifier with 2000 volts on the plate and 300 volts on the screen. The amplification factor of the tube as a whole, as given by the tube tables, is 200, which, when divided into the plate voltage of 2000, gives us 10 volts as "cut-off bias". This method is improper for



# Ham Hints

By JAYENAY

screen grid tubes. It has been found that when we consider the screen grid as the plate, the amplification factor of this triode portion of the tube is close to 6. Thus, when we divide the screen voltage of 300 by the amplification factor of 6, we obtain the correct value of bias necessary to cut off the space current. In this case, it equals minus 50 volts on the control grid. The same procedure is used in estimating the proper bias for class C use.

## Amplifying the Output of a Carbon Mike

IT HAS been determined that the output of a good double button mike varies tremendously with the distance between the mike and the speaker, up to about two feet. The output at two feet is about one thousandth of the output when the speaker's lips are only an inch or so away from the microphone. This amounts to more than two stages of transformer-coupled 56's. In general, the higher the quality, the more gain required. It has been found that three stages of resistance coupled 56's are just barely sufficient to swing the grids of a pair of push-pull 46's when a Western Electric 387W mike is used, speaking one foot away. Incidentally, there is no point in raising the button current above 7 1/2 mills per button on ANY make of mike, because the increase in output is small and distortion and hiss rise rapidly above this point. NEVER move the mike around with the button current on. It pays to use a variable resistor with an off position to cut the mike current off. If you have no variable resistor with an off position, use any variable resistor of about 1000 ohms and then see that the button current is cut down to a minimum before opening the battery switch. Opening the battery circuit with the button current on throws a big inductive kick through the buttons which causes arcing, which will ultimately destroy the glaze on the carbon granules and thus pack-up the mike.

Most broadcast stations are getting rid of their carbon mikes. Good ones are cheap. It is almost impossible to tell the difference between a high quality carbon mike and a condenser or ribbon mike, provided there is enough gain in the speech amplifier to allow the use of a low button current and at least one foot of distance between the speaker and the mike.

## How Many Turns To Hit Forty?

90 per cent of the technical inquiries addressed to "RADIO" ask to give exact coil specifications to hit a certain frequency with a 1926 model Nationalund or Pilowell condenser (size usually unspecified), from which half the plates have been removed. No details as to the coupling method or the internal capacity of the associated tube or tubes are given. In defense, we usually specify medium-high C because most hams find it easier to add capacity than to eliminate turns. Some efficiency is sacrificed because low C tank circuits allow the use of higher impedance plate loads.

Here is a method of finding how many turns are necessary to just hit the desired frequency with the condenser plates nearly out, which is desirable. Build the amplifier stage and make a test tank coil about ten to twenty per cent larger than you think is about right. Then use a shorting clip to progressively short-out some turns on the tank until resonance is found with just your particular amount of C in the circuit. When the correct number of turns is determined, you can cut off the excess turns and then permanently mount the tank coil.

If the newcomer will appreciate that the number of turns on a forty meter 3 inch tank coil can vary as much as 150 per cent, depending on the associated capacities, he will see why it is so hard for anyone to give exact dimensions of the coils for his transmitter. Therefore, cut and try and use all the turns you can. Ordinarily Bakelite should be avoided for coil forms. The use of low-loss Ceramic or Mica materials pays big dividends in increased output and efficiency.

Use good tank condensers and keep them as small as possible. 25 to 50 micromikes is ample capacity for everything except possibly 160 meter operation, and not more than 100 micro-mikes will be necessary for 160. Cheap midget condensers in tank circuits are to be avoided. If you must use them, it is advisable to solder a flexible connection directly to the rotor shaft and thus avoid the troubles resulting from poor bearing contact.

## A Thumbnail Sketch of The New Tubes

### RCA-801

● The first of the season's crop from the RCA Tree is the RCA-801, an overgrown 210 with a carbon plate and a 7 1/2-volt thoriated filament. Its mu is 8, and it can be used at full ratings, down as low as 5 meters. Its size is about halfway between the 210 and the 830.

### RK-23

● A pentode with suppressor grid brought out to external connection for modulation purposes. Data highly tentative. Plate lead seems to come out of top. We suspect it will have a 2 1/2-volt indirectly heated cathode. Looks like a good triode or pentode crystal oscillator and is reputed to give 10 watts output with 400 volts on the plate, 200 volts on the screen and 40 volts positive on the suppressor. About 3 watts of phone carrier is expected with the suppressor grid 60 volts negative. Approximately 80 volts of audio swing and 24 milliwatts of audio power effects 95 per cent modulation of the carrier. This tube is from the Raytheon Tree.

### RCA-802

● The 802 looks somewhat similar to the RK-23 in that it is a pentode and is scandalously related to the 865, 2A5 and the 47. Has an indirectly heated 6.3-volt cathode and is rated at 400 volts on the plate at 50 mls maximum. 200 volts is the recommended screen voltage. The plate lead is brought out at the top of the tube. The suppressor grid is brought out to a separate base pin, which enables the suppressor grid to see life. This tube is from the RCA Tree.

### EIMAC 50-T

● Little brother to the 150-T. Five-volt, 6-amp filament. Its mu is 13, plate voltage anything between 600 and 3000 volts. UX base. Plate lead at top. Grid lead at side. Normal maximum plate current 100 mls. Useful clear down to one meter. This tube is from the Eimac Tree.

### RK-21

● Half-wave thermionic (not mercury vapor). High vacuum, identical in overall size to the 866 or 866A. Filament takes 2 1/2 volts at 4 amps. Maximum peak plate current 600 mls. Maximum inverse voltage 3500. Is usually interchangeable with 866 in low voltage circuits. This new tube is from the Raytheon Tree.

### RK-22

● High vacuum, full-wave thermionic rectifier. Similar to RK-19 except for filament voltage, which is 2 1/2 volts, instead of 7 1/2 volts as used in RK-19. Filament current is 8 amps. Equivalent to two RK-21s in one envelope. Inverse peak voltage 3500 volts. Maximum peak plate current 600 mls. Developed primarily for aircraft use. This tube is also from the Raytheon Tree.

### HK-354 (Modified)

● The second edition of the justly famous 354 Gammatron. Same 5-volt, 7.75-amp. filament. Slight mechanical modifications, including larger envelope, spiral grid support, new "knee action" plate support. Same 50-watt base. Average mu 12. Plate voltage 1000 to 3000. Maximum plate current 175 mls. This tube is from the Heintz & Kaufman Tree.

### RK-10

● Husky 210 from the Raytheon Tree. 7 1/2-volt thoriated filament. Isolantite base. New filament support and better seals than used in receiving-type 10s.



## PRESENTS A COMMUNICATIONS RECEIVER

With features you have always wanted and at a price you can afford to pay—\$69.50 complete.

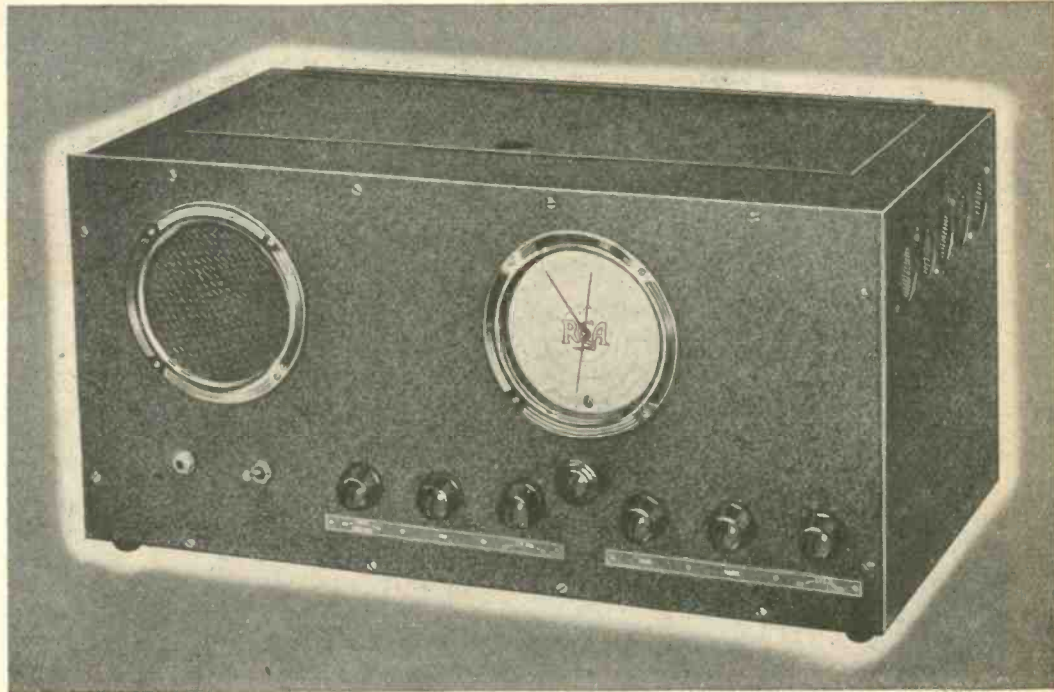

### THE ACR-136

The ACR-136 is a seven-tube superheterodyne receiver covering from 540 to 18,000 kilocycles. Pre-selection, A. V. C., front-panel band-switching, and a mechanical band-spread system with calibrated dial and vernier pointer which permit positive logging of any station, are outstanding features of this new amateur receiver. Both r-f and a-f gain controls are provided to permit unusual flexibility in controlling background noise. The tone

quality is exceptional for this type of receiver. These features plus excellent sensitivity and selectivity make the ACR-136 an outstanding value. ★ ★ The ACR-136 is supplied complete with tubes, speaker and power-supply (self-contained). There is nothing else to buy, yet the net price to the amateur is only \$69.50, f. o. b. factory. ★ ★ For more complete information and the name of your nearest amateur sales outlet handling the ACR-136, write to:

AMATEUR RADIO SECTION  
**RCA VICTOR COMPANY, INC.**  
CAMDEN, NEW JERSEY

# A Trans-Portable Radiophone

By DEE ROWSELL, W6EWX

HERE is a portable phone that can be carried easily and set-up in a few minutes' time. An AC-operated portable is cheap to build and can be condensed into a minimum number of units for complete operation. The transmitter here described is capable of 15 to 20 watts input on 40-80-160 meters. On 20 meters the output is around 8 watts.

Many pages have been written on portables, but few of these concern phone transmission for three bands. The rigid requirements call for complete modulation with full power output, and a good signal on any one of the three bands used.

## THE CIRCUIT:

In designing the RF portion of the transmitter, consideration was given to the best set-up for four band operation. Therefore the use of the 59 as a tri-tet oscillator becomes the obvious choice. The 59 also furnishes sufficient buffer action as a tri-tet to warrant its use for modulation, limiting the use of an extra buffer. Since the 45 is the final amplifier running at 20 watts input, the logical modulator tube is the 53 in class B. Being small and of the dome type it lends itself admirably to much more abuse than the filament tubes. The 53 can be mounted in any position without fear of the filament sagging. This tube has an audio output of 10 watts at 300 volts. A 53 as class A driver gives sufficient driving power for the class B stage for full output. One power supply handles the entire transmitter; the power transformer is 400 volts, 150 MA. One filament winding takes care of all filaments, and one winding for the rectifier. Two small 100 MA chokes are used, one 30 henry, and one 5/25 henry. Two 16 mfd. for filter are sufficient and no noticeable hum can be detected on the air.

## CASE ARRANGEMENT:

The cases used for the transmitter are of the Army Signal Corps type, known as BC-101. The cases have removable bakelite panels so that the transmitter becomes easily accessible if repair becomes necessary. The case measures 7 1/4 x 9 and is 6 inches deep. A small door in the top part of the front panel makes itself useful for ventilation and also serves as an opening to change the plug-in coils for the final amplifier. The small door in the rear of the case can be used to remove the tubes.

Attention is given to the modulator case for the distribution of weight. The power transformer is mounted directly in the center of the case, on the lower shelf, while the chokes and rectifier are on one side of the transformer; the filter is on the other. The case, when being carried, practically balances itself in the hand. The tubes for the modulator are horizontally mounted and they can be removed through the small opening at the top of the panel. The audio transformers are mounted between the tubes on the same shelf, keeping them as far away as possible from the power supply.

The coils used are of the plug-in type. For the oscillator coil, tube bases were used to conserve on space. The final amplifier coils are wound on 1 3/4-in. tubing. In order that the tube can be removed it is necessary to mount a bakelite strip one inch above the brackets which supported the shelf in the case. This is the strip where the jacks are placed for the final coil to be plugged into. This method of mounting also leaves sufficient room for the coils to be removed. Each coil is given two good coats of Duco to make

(Continued on page 36)

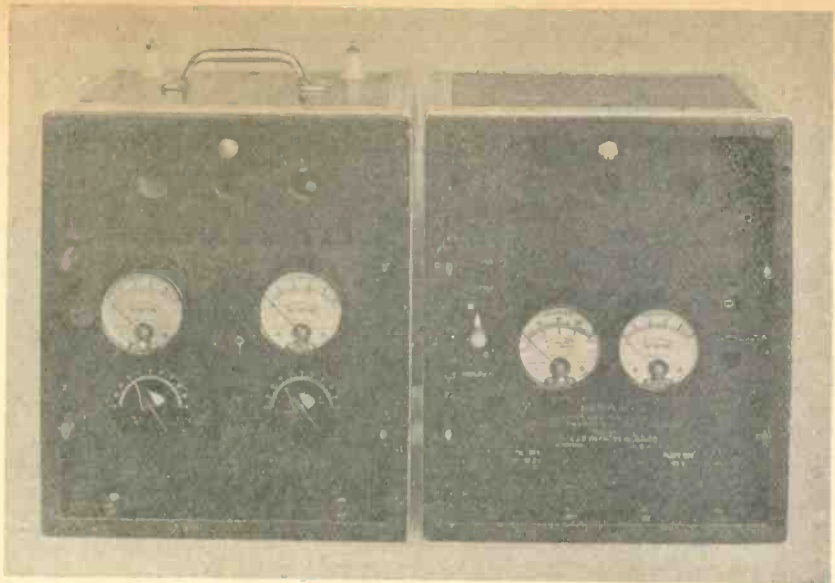

Front view of the RF portion in one carrying case, and the power supply in another.

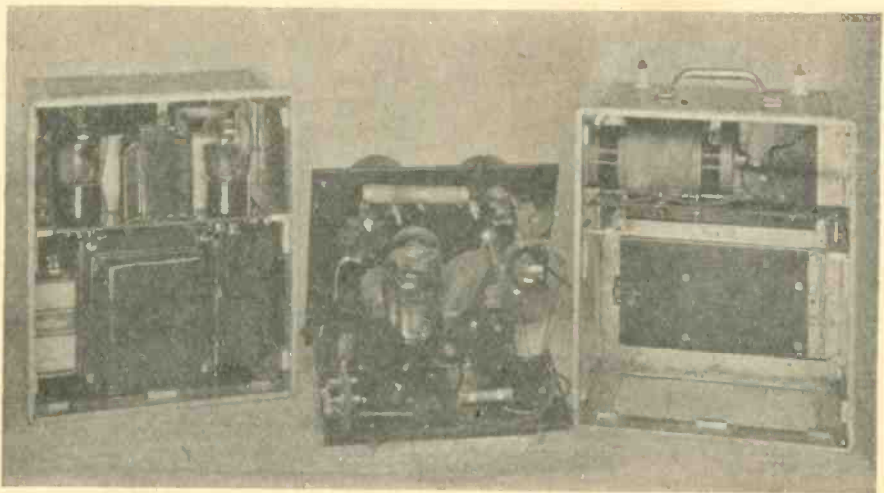

Three Interior Views showing correct placement of parts for hum elimination and weight distribution.

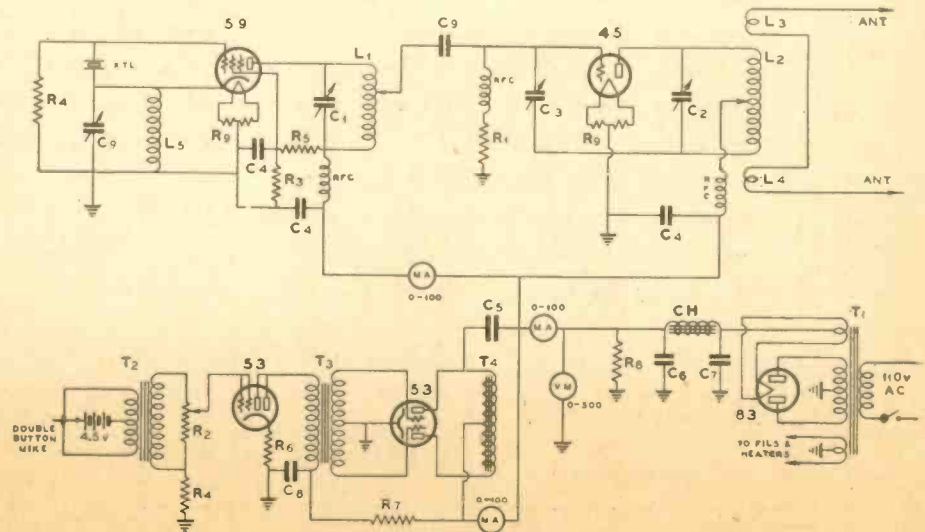

Circuit Diagram for Trans-Portable Radiophone

The output choke used is one of the 30 henry 80 mil. Dongan dual filter types, found in many of the old TRF sets. 5500 turns each section. No. 34 wire is used. The peak current of the 53 is only 70 milliamperes, therefore a choke can be home-built without difficulty. Its insulation can be practically any good grade of paper. The core size of the choke is 1 1/2-in. x 1 3/4-in. x 1/2-in.



# PR-12



## • the ultimate in DX for 1935!

• Amateurs—and non-professional devotees of the science of DX communication—throughout the world have asked if there is a receiver that will out-perform the sensation of the 1934 season: the incomparable Patterson PR-10!

• Today the answer is: Yes! But one, however: PR-10's successor model: PR-12! With greater range—8-550 meters; sensitivity still finer; selectivity even more acute; the PR-12 will out-perform any set—at any price—on any band! And this world challenge includes tone, also.

• Designed and engineered under the personal supervision of E. R. Patterson, pioneer American manufacturer of super-quality receivers (since 1920!) this magnificent engineering achievement incorporates every proven feature of value: several of which are distinctive and entirely exclusive with the Patterson Laboratories, again leading in original and constructive accomplishment—as for the past 15 years.

• Convince yourself of the outstanding superiority of PR-12 by contacting your nearest Patterson jobber at once. Arrange for a demonstration immediately. You will be amazed—as is every other Amateur who has subjected this remarkable receiver to every possible test.

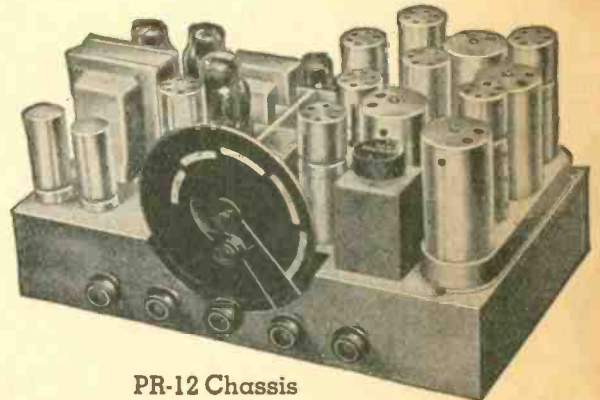

PR-12 Chassis

### 56 FEATURES . . . among them are:

- Higher sensitivity; greater selectivity.
  - Uniform gain over entire range.
  - Full range, 8 to 550 meters.
  - Shielded 100 per cent.
  - Patterson Selector-Band Dial: airplane type; shows only band in use; microthermic 2 speed tuning; 10 to 1 and 50 to 1 reduction; anti-backlash rubber drive.
  - New 6 section tuning gang condenser gives an exceptionally low C tuned circuit resulting in extremely high gain (approximately twice) on the short-wave bands, equalling or surpassing plug-in coils.
  - Newly designed coils, with new type of switch, lowering the amount of dielectric loss and skin effect in tuned circuit.
  - Pre-selection ahead of first detector results in higher signal to noise ratio, decreasing amount of image response to a minimum; increasing sensitivity, overall gain and selectivity.
  - Modulation and R meter.
  - Crystal filter, which can be cut in as a series or parallel filter; affords two degrees of selectivity, further raising signal to noise ratio and increasing selectivity.
  - Monitor switch, for use in checking quality of your own transmission; percentage of modulation indicated visually and orally.
- (NOTE: •• indicates NEW; ••• indicates NEW and EXCLUSIVE!)

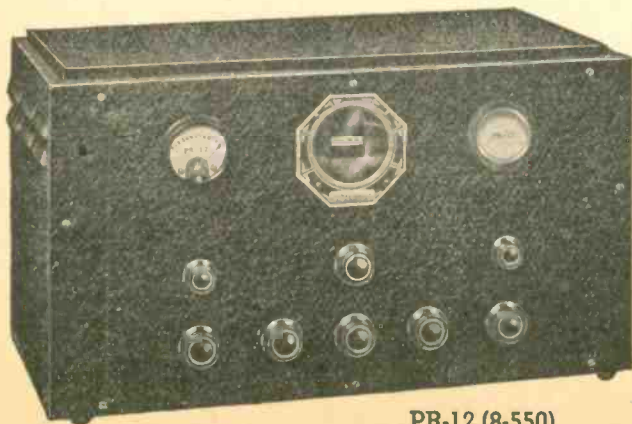

PR-12 (8-550)

#### List Price Complete—Absolutely Nothing Else to Buy!

PR-12C—Chassis, Tubes and Speaker . . . . .	\$129.50
PR-12—in Metal Case . . . . .	139.50
PR-12K—in Console . . . . .	169.50
Add for Complete Crystal Control . . . . .	10.00
Add for any voltage or cycle other than 110 Volt AC, 50-60 Cycle (not made in Battery type) . . . . .	4.00

A discount of 40% from the list prices is extended to the amateur and experimenter.  
All prices F.O.B. Los Angeles. Patterson standard R.M.A. guarantee of six months.

## PATTERSON RADIO COMPANY

*Manufacturers*

**1320 So. Los Angeles St., • Los Angeles, U.S.A.**

# HARRISON FOR VALUE!

WESTINGHOUSE  
OIL FILLED CONDENSERS  
3 MFD. — 1200 VOLT (Working)

New oil immersed high voltage filter condensers. In neat, compact aluminum containers adaptable to sub-panel or baseboard mounting. Full 3 Mfd. Rated for continuous duty at voltages up to 1200 volts DC!

Oil Impregnation means extra long life!!

While They Last  
Three for \$2.35 **89c ea.**  
30 Day Free Replacement Guarantee

**866** HEAVY DUTY 60 Day Guarantee **\$1.25**  
**210** HEAVY DUTY 15 Watt **99c**

## G. E. NEON BULBS

Small, super-sensitive, screw base—FB for neutralizing, etc. 3 for 50c. ½ or 1 watt, 38c. 2 watt, 45c. **8 for \$1**  
Postpaid

## 100 WATTERS, \$14.75

U. S. ARMY TYPE 860 SCREEN GRID.  
Regular Price, \$35.00. An FB BARGAIN!!

## Thordarson Power Choke

8 Henry—400 MA  
Neatly metal cased. FB for in-put choke. 3000 volt insulation. **\$1.35**

## 50 WATTERS

Brand New! First Grade! Fully Guaranteed! **\$5.95**  
Type 211, 846, 242, 811, 872 \$7.95  
RCA 955 Acorn Tube \$3.75, postpaid

## "THE TRADING POST"

Good used equipment bought, sold, exchanged  
What Have You? What Do you Need?

## S.W. RECEIVERS, \$3.75 UP

Send for Literature  
Pigtail resistor type 2½ Mh RF Chokes, 19c.  
SIX for \$1.00. General Electric Meters, 2"  
D'Arsonval movement. Zero adjuster. Front  
panel mount. With instructions and shunt wire  
to convert to any desired DC Milliampere  
range \$1.25

ORDER NOW! We guarantee satisfaction  
or money back!!

# HARRISON RADIO CO.

142 LIBERTY ST., Dept. PR-1, NEW YORK CITY



## NEW EDITION Now Ready

The only Radio Call Book published that lists all of the radio amateurs throughout the entire world.

Also a complete list of high frequency commercial stations, international abbreviations and amateur prefixes, "Q, R, & T," systems for reporting signals, New US radio inspection districts, high frequency press, time and weather schedules, and high frequency commercial stations listed by frequencies.

Every ham should have one. Always up-to-date. Single copies \$1.10. Annual subscription \$3.65.  
RADIO AMATEUR CALL BOOK, INC.,  
600 SOUTH DEARBORN ST. CHICAGO, ILL

## The Intercept Watch

(Continued from page 24)

they decided to build an even better one. When this plan was put into practice, the faithful little Hartley was partly disconnected and certain pieces used in the construction of the new outfit. When the new job was finished, K7BOE and K7BND (for father and son each had a station license now) broke forth on the North Pacific ether with added volume.

And then the worst disaster of all happened, the scourge of small Alaskan villages, and especially those of the westward, where lumber it at a premium.

The Hanson home was burned—burned to the ground—and most of the radio apparatus with it. There were some parts saved, however, and I believe they were united with the remainder of the original Hartley and put on the air as K7BND. I worked Virgil a number of times last spring and summer, when he was using this improvised transmitter. It didn't have the zip and zest of the higher powered transmitter, but there it was, cutting through interference—the little old Hartley, right on the job!

## RCA-ACR Receiver

(Continued from page 18)

put of the beat-frequency oscillator into the detector circuit. This method is new and affords maximum isolation between the 6B7 second detector and the 6D6 beat oscillator, which uses a conventional Hartley-Dow electron-coupled circuit. The beat frequency oscillator is effectively shielded and the plate lead is filtered and by-passed by means of resistors and condensers in order to prevent any of the BFO output from leaking into the first detector or into the 6D6 IF amplifier.

The beat oscillator is provided with an on-off switch for phone reception.

It is found that shielded leads are extensively used between various portions of the detector circuit. This method prevents radio-frequency overloading of the pentode portion of the detector tube, which is used to amplify audio frequencies only. This first stage of pentode audio frequency amplification is resistance coupled through the grid circuit of a 41 output tube, which feeds a built-in loudspeaker. Headphone reception is provided at the output of the 41 tube by means of a jack on the front panel of the receiver. The audio volume control consists of a 250,000-ohm potentiometer which acts as a load resistor for the detecting diode. When headphones are used, the speaker is cut out.

Extensive grid and plate decoupling is provided in the audio amplifier in order to improve fidelity and to minimize regeneration. A high-frequency tone control is applied to the plate circuit of the 41 output tube. This enables the higher audio frequencies to be attenuated, with a consequent reduction of background noise. At the rear of the chassis is located a switch which permits a variation of the low-frequency audio response of the receiver.

The choice of either manual or automatic volume control is made by a switch on the front panel. This switch removes the DC grid returns of the 6D6 RF amplifier, the 6A6 detector and the 6D6 IF amplifier from a tap on the diode load resistor to ground, through a 4000-ohm resistor, when the AVC is disconnected for CW reception.

The power supply is conventional, except for the front-of-panel switch which cuts off the B voltage when a transmitter is used. A particularly convenient tuning knob is used. The tuning dial utilizes a main double-edged pointer which covers three scales calibrated in megacycles and a second pointer which is used for band-spreading. This band-spread pointer is permanently geared to the main tuning pointer.

BUD RADIO PARTS are specified by AMATEURS, EXPERIMENTERS and ENGINEERS for QUALITY, EFFICIENCY, and ECONOMY.

## Bud Isotex Coil Forms

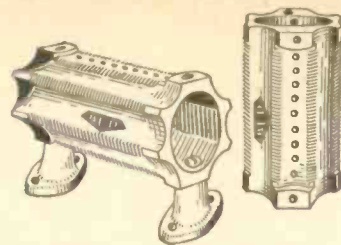

Suitable for 20, 40, 80 and 160 meter oscillators, amplifiers, etc. This form is threaded for No. 10 wire or smaller and drilled with sufficient holes for wires and supports. ISOTEX is a specially impregnated moulded ceramic material having exceptionally low loss properties. Size of from 3" O.D. x 6" long, and threaded for thirty-four turns of wire.

No. 376. Coil only, no supports.....\$2.50  
No. 377. Coil with supports and hardware.....\$3.00

Your Favorite Jobber Stocks BUD RADIO Parts  
Write for New 1935 Catalog

List prices shown in this advertisement are subject to 40% discount when purchase is made from an authorized BUD jobber. If your jobber cannot supply BUD parts, send your order direct to us together with your jobber's name and we will make shipment direct.

## BUD RADIO, INC.

1937 E. 55th St. Cleveland, Ohio

## LENZ

### MICROPHONE CABLES

are constructed for perfect transmission of voice and sound. Eliminate man made interference and "HUMS."

Perfect  
for Short  
Wave



Shielded Rubber Covered

### A New Item That Is Popular

CRYSTAL  
MICROPHONE  
CABLES

For Sale by Leading Jobbers and Dealers Everywhere

West Coast Representative:

FRANK A. EMMET

741 S. Burnside Ave., Los Angeles, Calif.

## LENZ ELECTRIC MFG. CO.

1753 N. Western Avenue, Chicago  
Please send me your new Catalog No. 21

Name \_\_\_\_\_

Address \_\_\_\_\_

City \_\_\_\_\_ State \_\_\_\_\_

## QUALITY

at a Price You Can Afford to Pay!

## FRANKLIN Transformers

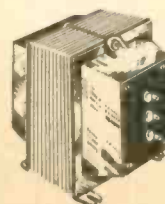

Very conservative ratings on Transformers and Chokes for every Amateur Station.

"MOST SOCK PER DOLLAR"

Write for Catalogs

FRANKLIN TRANSFORMER MFG. CO.

607-609 22 Ave. N.E., Minneapolis, Minn.

# AEROVOX



for **DEPENDABILITY**

IF you want that transmitter to stand up and deliver the goods year in and year out, with least cost to you, see that it's equipped with . . .



- AEROVOX Oil-Filled Transmitting Condensers . . . quality inside and out . . . latest engineering . . . remarkable performance . . . longest life . . . and irresistible prices (for example: 2 mfd. 2000 v. \$6.50 list!)
- AEROVOX Grid Leak Resistors . . . also for voltage dividers . . . adjustable contact slider . . . wire-wound, vitreous-enameled . . . heaviest duty work.
- AEROVOX Mica Condensers . . . precision units . . . bakelite molded . . . lowest dielectric losses . . . small in size and price but gigantic in usefulness.

And remember that Aerovox offers all other types of condensers and resistors for dependable, economical, trouble-free service.

**New Catalog** . . . 1935 Edition just off the press describes complete Aerovox line. Also free copy of our monthly Research Worker.



**CORPORATION**

84 Washington St. :: Brooklyn, N. Y.

## The Last Word on RADIO DESIGN!

3 books every "Ham" and Service Man "should read," says The N. Y. Sun



Have the benefit of newest developments. These books, by expert, tell all—give modern as well as anticipated improvements. All explained simply and clearly illustrated.

Broadcast Receiver Design.  
High-Fidelity Receiver Design. } By G. S. GRANGER  
All Wave Receiver Design.  
\$1.00 complete set. Order direct from per copy 50c.  
MANSON PUBLISHING CO.  
521 Fifth Ave., Dept. R New York City

## Power Modulation and Efficiency Modulation

(Continued from page 21)

der certain conditions, the vacuum tube amplifier can be operated so that the control grid draws no DC current, even when most positive, so that the modulator tube need supply no power at all in order to effect deep modulation, as the effective grid impedance is, in that case, infinite. Usually it is poor economy to operate a radio-frequency amplifier control grid wholly on the negative side of zero bias because the efficiency of plate power conversion is then usually quite low, unless high plate voltages are used, together with a tube of exceptionally high mutual conductance. Thus most grid-bias modulated amplifiers operate so that some DC grid current is drawn, at least on the peaks of modulation.

### The Linear Amplifier

As far as the plate circuit is concerned there is absolutely no difference between grid-bias modulation or grid-excitation modulation, which is simply another name for the Class B Linear Amplifier.

In one case, the excitation is kept constant and the DC bias is varied at an audio frequency rate. In the Linear Amplifier the DC bias is kept constant and the amplitude of RF grid excitation is varied at an audio rate. The excitation is varied by merely modulating in some preceding amplifier stage, by means of either power modulation or some form of efficiency modulation. The maximum possible power output and plate efficiency of a linear amplifier, for a given tube and given plate circuit conditions, is exactly the same as for a similar grid bias modulated amplifier. It is usually more economical to modulate the DC grid bias than to use an already-modulated RF wave to obtain the modulation of the final power converter stage, because power modulation of a buffer stage always requires the use of more audio power than would be required to grid-bias modulate the final stage directly. It must be kept in mind that while the power in the sidebands of the previously-modulated wave, and the power that must be applied to vary the DC grid bias are exactly the same for a given degree of modulation, for a given stage, power modulation of the previously modulated stage was applied to the input of that buffer stage, and not to its RF output. Likewise, it is impossible to transfer the modulated power from the plate circuit of the previously-modulated buffer stage to the grid circuit of the final stage without losing some energy on the way. No coupling device can be 100 per cent efficient, especially at radio frequencies, so that in general at least twice as much audio power is necessary to effect grid-excitation modulation as would be necessary to effect grid-bias modulation at that same stage.

A Linear amplifier or a grid-bias modulated amplifier can be operated, with conventional tubes and power supplies, under conditions that allow unmodulated plate efficiencies in the neighborhood of 35 to 40%. To obtain such high unmodulated efficiencies it is necessary to utilize fixed bias equal to "cut-off", plus enough cathode resistor bias to cut the time of plate current flow to that desired. This is the class B Prime system of operation. The total amount of bias will usually be approximately equal to the bias that would be used on that same amplifier stage operated as a Class C amplifier at the same values of plate voltage and load resistance in the plate circuit (antenna coupling).

### Screen-Grid and Suppressor-Grid Efficiency Modulation

Practically all screen-grid tetrodes and pentodes built at the present time are in-

(Continued on page 36)

## 'HAMS' Here is the OHMITE Amateur

H  
A  
N  
D  
B  
O  
O  
K

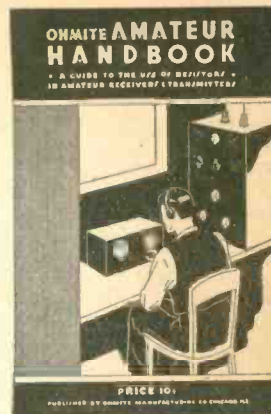

Here is the Handbook you have always wanted . . . sixteen pages of resistor and rheostat data needed by every amateur . . . how to select bleeder resistors, voltage dividers, filament rheostats, plate supply systems, etc. Ingenious tables and charts eliminate formulas and calculations and save 90% of the work. The Handbook also contains data on a new AC-DC Frequency Meter Monitor, a Class-B Modulator, wattage and resistance charts, Ohm's Law Charts, new MULTIVOLT tapped resistors, power rheostats, etc.

Price 10c

Use the coupon below or see your parts dealer for the biggest dime's worth you ever received.

---OHMITE---  
MANUFACTURING COMPANY  
629 N. Albany Ave., Chicago, Ill.

Enclosed find 10c for my copy of the OHMITE AMATEUR HANDBOOK.

NAME \_\_\_\_\_  
ADDRESS \_\_\_\_\_  
CITY \_\_\_\_\_ STATE \_\_\_\_\_

## ANKER-CRUISER

3-TUBE A.C.-D.C. SET

WORLD-WIDE RECEPTION

KIT  
\$10.45  
NET



- **OUTSTANDING FEATURES**
- Electron coupled feedback, 3 tubes, 6C6, 43, and 25Z5, humfree built-in 110 AC-DC power supply, front panel plug-in coils, front panel phone plug, automatic speaker cutoff, hinged cover black cracked metal cabinet, 13 to 200 meters—Complete Kit of Parts, including 4 front plug-in coils, hardware, diagram, instructions, etcetera. List, \$17.41; net \$10.45. Wiring and testing, list \$3.40; net \$2.05. Broadcast coil, list, \$3.99; net, \$.59. Kit of Arcturus Tubes, list, \$3.95; net, \$2.37. Ankerlite phone, list, \$1.75; net, \$1.05. Order from this page. Free Anker Catalog on Request.

ANKER LABS

20 W. 22nd St. Dept. R-11 New York City

## A Transportable Phone

(Continued from page 32)

connection should be from 1½ to 2 inches each side of antenna center. A resonant line, such as a zepp feeder, can be used if it is not too many quarter-wavelengths long.

The insulating panel upon which the 955 tube was mounted was an ordinary ½-inch sheet of bakelite. A hole was drilled through this panel, large enough for the lower part of the 955 tube to fit into the hole. The lead clips were mounted by means of small machine screws. A hacksaw blade was used to saw a slot between the grid and plate clips so as to reduce dielectric losses. A copper plate mounted directly under this panel seemed to do more harm than good, insofar as super-regeneration is concerned; thus it was discarded.

Tuning the circuits to resonance is accomplished approximately by means of a Lecher wire system. Half wave points, about 14 inches apart on the Lecher wire system, can be heard in the receiver when it is inductively coupled to the detector circuit. More exact

tuning was accomplished by means of a 5 meter transmitter. One of its harmonics was used to produce the usual dead spot in the super-regenerative hiss of the ¾ meter receiver. By noting the dial readings on the 5 meter transmitter which produce "dead" spots in each ¾ meter receiver, these dial readings can be brought to the exact same reading. This was done by means of a hot soldering iron and by sliding the condenser bridge along the ¾ meter parallel wire circuit.

The case is about 6-in x 5-in. x 5½-in. If high audio volume is desired, an additional audio amplifier would be desirable and the 955 tube must be cushioned, or removed from the proximity of the loudspeaker. This new tube offers a wide field for experimenting with wavelengths below 1½ meters. It is capable of putting out more power than a 27-tube used in the usual parallel wire positive grid and negative plate circuits. Legend and coil data mailed on request.

•••

## ¾ Meter Transceiver

(Continued from page 27)

them moisture-proof. The antenna coils are wound directly over the plate coil; they use the same number of turns as the plate coil.

The modulator control is the key to the left of the panel. The toggle switch to the right controls the incoming power. The two flashlight cells alongside the microphone transformer are for the microphone supply. The control in the center is the volume control, mounted directly between the two meters. The meter in the plate circuit of the class B stage reads the current, which should be 60-65 milliamperes for full modulation. The arrangement shown here is the only one that gave the minimum amount of hum.

### IN ACTION:

This transmitter has been operating for the last two months in a congested area on the three phone bands and has done very well, considering the great number of higher-power stations on the air most of the time. The antenna used is 132 feet long, with a .0005 condenser in series for tuning. The reports given with the antenna four feet off of the ground were as good as when it was 40 feet in the air, for local operation.

## THE WUNDERLICH TR

5 Meter Transmitter and Receiver  
(Not a Transceiver)

The new Wunderlich TR mobile transmitter-receiver is the answer to the 5 meter Transceiver QRM problem. Four tubes for economy, simplicity and low current drain. Uses 71A as transmitting oscillator, 41 as modulator and audio amplifier, 6D6 as fixed tune radio frequency amplifier and a 76 as superregenerative detector.

Carrier output in excess of 8 watts. From ten to twenty times the output of average transceivers. Put out a real punch on fire for a chance. Particularly useful for mobile use as it is only 7"x7"x7" in a husky steel case. Non-radiating and ultra sensitive. Operates on anything from 90 to 350 volts, plate voltage.

See that your next 60 MC rig is a TR set, not a transceiver, if you want maximum power for your money.

Price \$27.50 less tubes

Designed by Frank C. Jones

WUNDERLICH RADIO CO.

190 Race Street, San Jose, Calif.  
High Frequency Transmitters Designed and Built

## TUNING CONTROLS

New Airplane Types



No. 121



No. 125



No. 123



No. 124



Remote Control  
No. 108

Some of the above units make ideal controls for the 5 meter Transceivers.  
We can also supply cabinets for your 5 meter or short wave set.

Above represents a few of our line of 30 styles of newest Airplane Type Controls, in addition to our complete line of conventional type controls, Escutcheons, Name Plates, Cabinets and other Specialties.

Write for our new catalog No. 55. Just off the press. Chuck full of the latest tuning controls, escutcheons, cabinets, name plates and other specialties. Twice the size of the last issue. Well worth sending for, plenty of valuable information.

Export orders receive special attention—Cable Address CROWNAME CHICAGO  
"Crowe Dials Make Tuning Easy"

**CROWE NAME PLATE & MFG. CO.**

1755 GRACE STREET

Established 35 Years

CHICAGO, ILL., U. S. A.

Pacific Coast Representative, W. BERT KNIGHT, INC.

## Power Modulation and Efficiency Modulation

(Continued from page 35)

capable of complete and linear 100% modulation when the AC modulating voltage is applied to the DC screen voltage. Western Electric has had some success in modulating the screen-grids of two cascaded RF amplifier stages.

It is theoretically possible to design a screen-grid pentode which will allow perfect and complete modulation to be effected by cascade screen voltage modulation, but such a tube has not been built to date and even if such tubes were available, the use of two cascaded efficiency modulated stages would be generally uneconomical as well as highly critical in adjustment.

Suppressor-grid modulation is used quite extensively among amateurs in the United States. If some means can be found to increase the unmodulated plate efficiency to around 40%, suppressor-grid modulation should become very widely used because it is probably the least critical modulation method of any, insofar as adjustment goes.

In all known efficiency-modulation systems, the plate power input must remain constant, if linear modulation is desired. The unmodulated plate efficiency could be about doubled if it were possible to make some form of grid-modulated amplifier release its own additional plate input from the DC plate supply source, during modulation. If this could be done, it would be desirable to have the plate efficiency remain constant under modulation and the amplifier would act much like a power modulated Class C amplifier, except that only a small amount of audio power would be necessary to effect deep modulation. This hypothetical form of amplifier has not been invented, at this writing, but it probably will be, if necessity is still the mother of invention. This description of the hypothetical amplifier is presented in the hope that it may help start some amateur thinking along the lines necessary to effect a solution to this problem.

In general, efficiency modulation is characterized by the fact that it is rather difficult to adjust, especially without an oscilloscope, and there is some question as to whether it is cheaper to use a large tube running at 35 to 40% plate efficiency and a minimum of audio equipment, or to use a small, high-efficiency class C amplifier stage together with extensive modulator and power supply equipment.

There are many good points to each side of the argument, and as modern efficiency modulation is still rather new to the majority of phone amateurs, it has not had an opportunity to really prove what it can do.

## How Long Must We Continue To Be Misinformed?

(Continued from page 6)

The most constructive criticism invariably presumes the destruction of the bad in order that the good may be revealed and have opportunity to prevail. I insist now that the ARRL, Inc., CAN be placed on the sound basis of an association owned and managed solely BY amateurs solely FOR amateurs. And I declare now that if this is not done the amateurs may as well junk what little remains of their frequencies and rights and count themselves out of the radio picture in America. They must act now if the amateur is to remain a factor in the radio affairs of the nation. Either they must act now to remove commercials, commercialism and the commercially subsidized from their own organization or else see the people's domain of the air taken over entirely by private commercial corporations.

CLAIR FOSTER, W6HM.

FORMS CLOSE ON THE 10th OF MONTH

RATES 10¢ PER WORD PAYABLE IN ADVANCE

**CLASSIFIED RADIADS**

CRYSTALS—80 or 160 Meter Bands, X or Y Cut, 1 inch square, Accuracy .002%, \$1.50. W8CHJ, 9255 Herkimer St., Detroit, Michigan.

WANT Service Equipment, Rider's Manuals, Etc. Trade Transmitting Parts. W6QW, Leslie Rosenblatt, Box 207, Livermore, California.

TRANSFORMERS—1,200 watt, 1200,2200,3200 each side, \$21.50. 225 watt 600-800 each side, \$6.75. Quotes given. Frank Greben, W9CES, 2012 S. Peoria St., Chicago, Illinois.

QSLs—First Quality, Snappy Service. Samples Free. W6KNM Ham Print, San Francisco, Calif.

FOR SALE—Transportable as described in this issue by Dee Rowsell. Original laboratory model, guaranteed in perfect condition. Complete with four Triplet Meters, but without tubes and microphone. Price \$65.00, which is the author's cost to build the model. For further details write to Dee Rowsell, 2370 Filbert Street, San Francisco, Calif.

WORLD-WIDE RECEPTION

**ANKER**

ALL-WAVE SUPERHETERODYNE

"DREADNAUGHT"

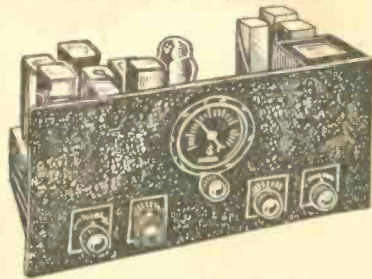

**QUICK FACTS**

- Continuous band spread.
- Standard parts used throughout.
- Easily lined up. I.F.'s prealigned.
- 7 tube all wave super-het circuit.
- Built in Beat oscillator.
- Power supply also built in.
- 9 1/2 to 550 meter range.
- Hi-ratio airplane dial tuning.
- Tone and static control.
- Hi signal to noise ratio.
- Front panel phone jack, automatic speaker cutout.

Foundation Kit consisting of drilled "Dreadnaught" chassis, black crackled panel, coil shield and complete directions including schematic and pictorial diagrams. Net price

**\$1.95**

The remaining material can be bought as desired.

Complete Kit, including all necessary parts, 4 pairs of plug in inductances 9.5 to 200 meters, hardware, diagrams, etc., etc. List \$49.85

**\$29.91**

NET

Less tubes and speaker

**ACCESSORIES**

Wiring and testing, list \$11.25. Net \$6.75. 2 pair of broadcast coils, 200 to 550 meters, list \$2.60. Net \$1.56.

Anker high fidelity dynamic speaker in cabinet to match receiver. List \$8.25. Net \$4.95.

Kit of genuine Arcturus tubes for "Dreadnaught," list \$7.15. Net \$4.29.

Black crackled metal cabinet with hinged cover, ventilating louvers, etc., list \$5.25. Net \$3.15.

If rack panel is desired instead of regular panel, additional list \$2.00. Net \$1.20.

Order Direct from This Page—Free Catalogue of Anker Products on Request

**ANKER LABS**

20 W. 22nd St., Dept. R-11, New York City

\$1 brings you the next four issues of "RADIO"—Subscribe NOW.

**THE RADIO SHACK**

OFFERS IMMEDIATE SHIPMENT ON RECEIPT OR ORDER

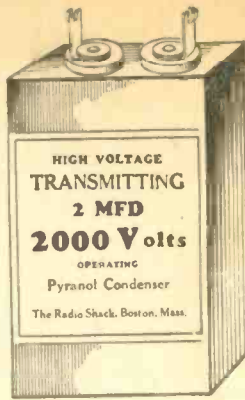

**PYRANOL CONDENSERS**

2000 VOLTS **\$2.50**  
2 MFD.

These Pyranol condensers are without doubt the finest filter condensers ever offered to the amateurs. The price is LOW and we warn you that when these are gone you will pay MORE, so buy yours now, and forget filter troubles forever. Many of the boys are using them on voltages up to three thousand and better. Believe us they are good.

- |                            |        |                             |        |
|----------------------------|--------|-----------------------------|--------|
| 866 tubes, Heavy Duty..... | \$1.69 | RCA S.B. Hand Mike.....     | \$1.75 |
| Triad 210 .....            | 1.25   | Baldwin Type C Phones.....  | 2.50   |
| Triad 841 .....            | 2.50   | V. T. 203 A (Graphite)..... | 9.00   |

COMPLETE LINE OF PARTS FOR THE AMATEUR

Mail orders filled by return mail. Send M. O. or check.

**THE RADIO SHACK** 46 BRATTLE STREET BOSTON

You Can Get It From **MID-WEST!**

We carry a complete line of all standard merchandise, shipped within 4 HOURS after order is received.

For Immediate Delivery

**New RCA - ACR-36 Amateur Receiver**

Complete with Speaker and Tubes..... **\$69.50**

New THORDARSON PLATE and FILAMENT TRANSFORMER No. 6878. A real transformer for Oscillator and Buffer stages. Note the specs—690-0-690 at 200 mils. 7 1/2 V. CT, 2 1/2 amps; 5 V. 3 amps; 2 1/2 V. 10 amps. Shipping Wt. **\$2.95**  
9 lbs. Specially priced.....

New No. 8500—30 henry 200 mil. CHOKE. 3000 V. Ins. DC res. 150 ohms. Open type mount. Shipping Wt. 4 lbs. Only..... **\$1.25**

New No. 8300 Special 5 henry 200 mil. INPUT CHOKE. 3000 V. Ins. DC res. 50 ohms. Open type mount. Shipping Wt. 3 lbs. Only..... **\$0.95**

SEND TODAY for our NEW FREE 68-page catalog of Exclusive Amateur Equipment.

**MID-WEST RADIO MART**

520 SOUTH STATE STREET, DEPT. R.

CHICAGO, ILL.

**POWERPLATE**

Prices to specified frequency (Amateur Bands)

- |                              |            |
|------------------------------|------------|
| X cut, AT cut or Ac cut..... | \$3.00 ea. |
| Y cut .....                  | \$2.00 ea. |

Commercial Crystals a Specialty

Piezo Electric Crystals for Transmitters, Receivers and Frequency Standards

**ALBERT F. HOEFLICH**

626 Sixteenth Ave. San Francisco, Calif.

FRANK C. J. N. A. **JONES & HAWKINS**

Consulting Engineers

Special High Frequency and Ultra High Frequency Equipment Designed and Developed for Amateur, Military and Commercial Communications.

2850 - 19th Ave. San Francisco, Calif.



"Since using your control I feel like a new radio." "Never performed better in my life," writes another. and so it goes . . . thousands of old, worn out, tired radios are being rejuvenated by alert servicemen with CENTRALAB replacement units.



The new patented RADIOHMS

And remember you can do a better job with a smaller stock of controls if you stick to

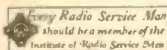

CENTRALAB

# Centralab

Division of GLOBE UNION, Milwaukee

RADIOHMS — RESISTORS  
SUPPRESSORS

## HIPOWER CRYSTALS & HOLDERS



TYPE M molded bakelite holder plugs in tube socket. . . . \$1.00

FREE plug-in mounting with each holder

HIPOWER CRYSTALS are cut from the most select Brazilian quartz. Cut one inch and ground for the absolute maximum output.

HIPOWER CRYSTALS are used in every branch of radio service—Broadcast, Commercial, Aircraft and Amateur Use.

You Cannot Buy a Better Crystal Than HiPower at Any Price

- Y cut within 10 Kc. of your spec. freq.
    - 1700-3500 Kc. bands . . . . . \$1.35
    - Y cut within 1 Kc. of your spec. freq.
      - 1700-3500 Kc. bands . . . . . 2.35
  - X cut within 10 Kc. of your spec. freq.
    - 1700-3500 Kc. bands . . . . . 2.35
  - X cut within 1 Kc. of your spec. freq.
    - 1700-3500 Kc. bands . . . . . 3.35
  - SPECIAL 7000 Kc. Band AH Cut. Entirely new.
    - More output . . . . . 4.25
- AT cut crystals for broadcasting and amateur use  
Immediate delivery

Send for Complete Data and Price List

HIPOWER CRYSTAL CO.

3607 N. Luna Ave., Chicago, Ill. Tel. Ave. 5170

## The Fire Underwriters' Regulations

By HARRY G. BURNETT, WILZ

**M**OST amateurs seem to regard observance of the Fire Underwriters' rules and regulations as an expensive and unnecessary task. To most of us, mention of these rules conjures a picture of impressive lightning switches, inconveniently mounted outside the shack, a flock of expensive insulators and one of those "unobtainable" good grounds. In addition, we visualize all power wiring neatly mounted on standoff insulators. All this preparedness for the remote contingency of a radio fire hazard seems unreasonable. We incline to become disgusted with the Insurance Companies who demand so much from us, and give their approval to fifteen-cent lightning arrestors for equally hazardous B.C.L. antennas. More often than not we proceed to forget about the whole affair.

Solving the problem by disregarding it, however, does not ease one's conscience. About a year ago I decided to find out just how much the Underwriters require for their stamp of approval. Rather than pore over tedious rules and regulations, I had a long talk with the chief inspector for the insurance companies here in Boston. An old-timer who has been inspecting amateur installations since the spark days, he surprised me by agreeing that the Insurance Companies had, in the past, been a bit unreasonable in their demands on the radio amateur. He then proceeded to explain how experience and common-sense reasoning has led the Underwriters to modify their rulings so that the amateur's pocketbook might be spared. The new code, as he outlined it, demands nothing but what our own good judgment would advise for sane protection against fire. Of prime importance, too, is the very low cost of the necessary equipment. In fact, most of us have part of the equipment already installed, and in all probability the rest of it may be found in the proverbial "junk-box".

It should be realized that the installation to be described is approved in Massachusetts. Local codes in other sections of the country may differ slightly. Since Massachusetts is known for its conservatism, it is believed, however, that the regulations elsewhere will be just as lenient. At any rate, the local inspector's advice should be sought before requesting an inspection.

A word about legal aspects may not be amiss. From the local inspector I learned that we are bound under contract with our fire Insurance Company to notify them when we install an amateur transmitter on the insured premises. If we fail to do this, and if a fire takes place, we may have some difficulty in collecting the insurance money, since our silence concerning the radio installation invalidates the contract. If, however, we advise the Insurance Company of the installation, but fail to comply with the regulations, we shall receive immediate notification that our premium rate has been raised. The average rate increase is about ten dollars. Since the equipment required by the Underwriters cost two or three dollars at the utmost and lasts indefinitely, it is cheaper to comply with the regulations. The premium rate then remains at its original value.

Now in Massachusetts, these Insurance people are interested in two things: an approved source of AC power, and adequate means for grounding the antennae when not in use.

(Continued on facing page)

## NEW Reduced Prices on ARCO Tubes

HIGHEST QUALITY BUILT INTO ARCO TUBES

Our Sales Policy Is: First Quality Merchandise, Rapid Service, Low Price, and a Square Deal. All Tubes are—

- 1—GUARANTEED FIRST QUALITY
- 2—R.C.A. LICENSED
- 3—FULLY REPLACEABLE UNDER R.M.A. STANDARD POLICY
- 4—UNIFORMLY WITHIN R.C.A. TEST LIMITS
- 5—ATTRACTIVELY PACKED

Complete Stock Ready for Immediate Shipment  
Order from this page—Remit 20% with order, balance C. O. D. All prices are F.O.B. FACTORY, Newark. Shipments go forward express or parcel post. No order for less than \$3.00 accepted.

Type No.	Fil. Voltage	Your Cost	Type No.	Fil. Voltage	Your Cost
1V	6.3	.50	75	6.3	.50
00A	5.0	.40	76	6.3	.45
01A	5.0	.30	77	6.3	.50
10	7.5	1.10	78	6.3	.50
12A	5.0	.40	79	6.3	.60
19	2.0	.60	80	5.0	.35
20	3.3	.40	81	7.5	1.10
22	3.3	.60	82	2.5	.45
24A	2.5	.45	83	5.0	.50
26	1.5	.30	84	6.3	.50
27	2.5	.30	85	6.3	.50
30	2.0	.45	89	6.3	.50
31	2.0	.45	X199	3.3	.45
32	2.0	.60	V-199	3.3	.45
33	2.0	.60	1A6	2.0	.85
34	2.0	.60	1C6	2.0	.85
35/51	2.5	.50	2A3	2.5	.85
36	6.3	.50	2A5	2.5	.60
37	6.3	.40	2A6	2.5	.60
38	6.3	.50	2A7	2.5	.60
39/44	6.3	.50	2B6	2.5	1.10
40	5.0	.40	2B7	2.5	.60
41	6.3	.50	5Z3	5.0	.50
42	6.3	.50	6A4/LA	6.3	.60
43	25.0	.50	6A7	6.3	.60
45	2.5	.35	6B7	6.3	.60
46	2.5	.50	6C6	6.3	.60
47	2.5	.50	6D6	6.3	.60
48	30.0	1.10	6F7	6.3	.60
49	2.0	.50	12A5	6.3	.85
50	7.5	1.10	12Z5	6.3	.85
53	2.5	.60	25Z5	25.0	.60
55	2.5	.50	12Z3	12.6	.50
56	2.5	.35	PZH	2.5	.85
57	2.5	.50	WD11	1.1	.85
58	2.5	.50	WD12	1.1	.85
59	2.5	.60	216B	7.5	.85
71A	6.0	.30	213	5.0	.60

### ● SPARTON TYPE TUBES ●

182B	5.0	.60	485	3.0	.85
183	5.0	.85	586	7.5	1.75
484	3.0	.60	686	3.0	.85

### ● KELLOGG TYPE TUBES ●

401	3.0	1.50	403	3.0	2.00
-----	-----	------	-----	-----	------

### ● MAJESTIC TYPE TUBES ●

2A7S	2.5	1.10	6Z5	6.3	.85
2B7S	2.5	1.10	24S	2.5	.60
2S/4S	2.5	1.10	25/25S	0.2	1.10
2Z2/G84	2.5	.85	27S	2.5	.50
6A7S	6.3	1.10	35S/51S	2.5	.75
6B7S	6.3	1.10	55S	2.5	.85
6C7	6.3	.85	56S	2.5	.60
6D7	6.3	.85	57S	2.5	.85
6E7	6.3	.85	58S	2.5	.85
6F7S	6.3	.85	75S	6.3	.85
6Y5	6.3	.85	85S	6.3	.85
6Z4	6.3	1.10			

### ● RECTIFIER AND CHARGER BULBS ●

125 Mil. rectifier tube B.H. (Raytheon type)	.....	\$1.25
6-10 Amp. triode charger Bulb (Tungar type)	.....	2.00
2 Amp. charger Bulb (Tungar type)	.....	2.00
5 and 6 Amp. charger Bulb (Tungar type)	.....	3.75
15 Amp. charger Bulb (Tungar type)	.....	7.50
UX-280M—5.0 Full Wave Mercury Vapor Rectifier	..	1.10
UX-281M—7.5 Half Wave Mercury Vapor Rectifier	..	1.90
UX-866—2.5 Half Wave Mercury Rectifier	.....	2.75
UX-871—2.5 Half Wave Mercury Vapor Rectifier	....	1.10
UX-872—7500 Volts Half Wave Merc. Vap. Rec.	..	11.00

### TELEVISION TUBES and PHOTO ELECTRIC CELLS

Photo Cell (Potassium), 2 1/2" Length Overall	.....	\$1.75
Photo Cell (Potassium), 3 1/2" Length Overall	.....	2.10
Photo Cell (Caesium Type), 4 1/2" Length Overall	....	7.90
Photo Cell (Caesium Type), 3" Length Overall	.....	5.90
Photo Cell (Caesium Type). Same as UX-868	.....	4.90
Television Tube (Neon Reflector), 1" Sq. Cathode	..	2.85
Television Tube (Neon), 1" Sq. Cathode	.....	2.85
Television Tube (Neon), 1 1/2" Sq. Cathode	.....	3.85

Specifications and quotations on TRANSMITTER TUBES, CRATER TUBES, GLOW LAMPS, HIGH VACUUM TYPE CATHODE RAY TUBES, suitable for television and standard oscillographic uses, SUBMITTED ON REQUEST.

### ARCO TUBE COMPANY

232 Central Ave.

Newark, N. J.

## NEW VICTRON S.W. PARTS

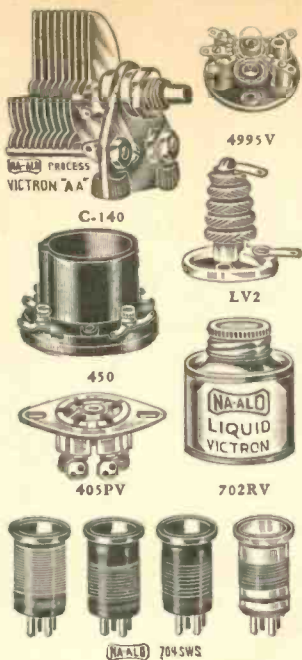

Don't sacrifice the low-loss properties of the new Acorn tube with poor insulation. Use the ultimate in low-loss insulation--VICTRON "AA," whose power factor at R.F. is only 0.0002. Everything you need for maintaining extreme low-loss in r.f. circuits is available—Condensers, Coils, Sockets, Stand-off Insulators, etc.

CAT. NO.	LIST PRICE
4995V Acorn Tube Socket (Victron "AA")	\$1.50
LV2 Liquid Victron Coil Dope per can	.35
702RV 2½ m.h. choke Victron insulated	.70
75V 5-meter choke, Victron insulated	.70
72V Victron Stand-Off Insulator	.35
C-140 140 mmf. Victron Condensers	2.50
C-50 50 mmf., \$2.40; C-15 15 mmf.	2.30
450 50-watt high quality molded socket	1.00
405PV Victron S.W. Chassis Sockets, each	.75
704SWS 18 to 200 meter Coil Set (Victron)	2.00

Victron Sockets, Coil Forms, Coil Selectors, etc.

Don't fail to write today sure for our new 16-page catalog showing precision wound coils of all kinds, short-wave, broadcast, long-wave, band-spread, etc. A wide variety of plugs and connectors, adapters of every description, switches, modern testing equipment, mike and power cables, dials, knobs, etc. Send stamp and your supplier's name for catalog.

**NA-ALD** ALDEN PRODUCTS CO., Dept. R  
715 CENTRE STREET, BROCKTON, MASS.

ASK THE HAM WHO OWNS A COPY!

120,000 Facts on 3000 Hams  
"WHO'S WHO IN AMATEUR RADIO"

packs them into 160 pages giving photos, personal and station data, on the liveliest bunch of QSO's ever gotten up between two covers.

50c A COPY

ON APPROVAL COUPON★

Radio Amateur Publishers  
1107 Broadway, N. Y. C.

Please send me a copy of the latest edition of "Who's Who." I agree to remit 50c in 5 days or return the "Who's Who" postpaid.

Name \_\_\_\_\_  
Address \_\_\_\_\_  
Call \_\_\_\_\_

"An approved source of AC power" means the ordinary baseboard or wall plug. Taking power for the transmitter from a light socket is taboo and really dangerous.

The inspector was disinterested in the rest of the power wiring. Fuses at the set are advisable, but not required. The wiring itself is subject to change so often that the Underwriters do not attempt to set up rules concerning it. It is very likely that state and city electrical inspectors would have more to say about this wiring. Local amateurs have discovered that it is advisable not to invite their searching inspections, unless the wiring is above reproach. But as far as the insurance inspector is concerned the power wiring was up to our own good judgment.

"Adequate means for grounding the transmitting antenna" means simply that there must be provision for attaching to the antenna a wire, the same size as that in the ground and is insulated from the house by insulators with a two-inch leakage path. The corrugations of the insulators are included in computing the leakage path. Therefore, medium-sized standoff insulators are sufficient to keep the antenna feeders and the ground wire the necessary two inches from the house on their way to ground. Lead-in insulators, also with a two-inch leakage path, are used to bring the feeders and ground wire into the house. A simple and approved means of attaching and detaching this ground wire to and from the antenna feeders is the only remaining problem.

In the old days there would have been a real obstacle in the purchase of two large lightning switches to be impressively mounted outside the shack window. At present, two ten-ampere clips of copper or brass suffice. These clips are fastened to two wires three or four feet long, the other ends of which are permanently connected to the feeder lead-in insulators on the inside of the house. The transmitter is placed near enough to the ground and feeded lead-in insulators to permit clipping the feeder clips on the transmitter antenna posts, or on the lead-in insulator going to the ground. The two wires, in either position, are kept two inches from the walls. If the local code should require the switching to be done outside the house, thus keeping all wiring outside, the procedure may be slightly modified. The clips may be fastened to the feeders at the point of connection to the lead-in insulators. The ground wire may be brought up to a standoff insulator near enough to the feeder lead-in insulators to permit easy switching of the clips from the feeder insulators to the ground insulator. Inside the house, the feeder insulators are connected directly to the transmitter as usual.

The ground connection may be made to a buried five-foot pipe, or it may be run into the cellar to a water-pipe. Nothing "fancy" is required. The shortest route to ground should be taken, however, and the best ground available should be used, so that a "good ground" will be available for other purposes.

Receiving antennas had best be protected by means of lightning arrestors. They are simple to install, require no attention, and will be approved. Indoor antennas, of course, require no protective devices.

It can be appreciated that the Underwriters' approval is an easier and cheaper task than it was. The comfortable, protected, and law-abiding feeling that this approval gives is worth a great deal to anyone. Then, too, those who have had experience with radio fires, like W8CRA, will probably assure us that the Underwriters are doing us a favor by requiring us to use the approved protective devices.

# AMATEUR ALL STANDARD LINES HEADQUARTERS WE SERVE YOU BEST.

SEND FOR THIS CATALOG!  
IT LISTS EVERYTHING FOR SHORTWAVE  
TRANSMITTING AND RECEIVING

Aerials  
Chokes  
Coils and Forms  
Condensers  
Crystals and Holders  
Dials and Knobs  
Insulators  
Jacks, Plugs  
Keys - Meters  
Monitors



Oscilloscopes  
Power Packs  
Preselectors  
Relays  
Receivers  
Resistors  
Sockets  
Transformers  
Transceivers  
Tubes - Tubing  
Wave Meter

### NEW EQUIPMENT

Receivers:  
NATIONAL "HRO"  
RCA-ACR 136  
Hammarlund "Super Pro"  
SUPER SKYRIDER

Transceivers:  
NATIONAL  
HARVEY  
HAIGIS  
KNIGHT

New Antenna Gear—New Tubes—and the complete National line. Write for This Catalog

## Allied Radio

ALLIED RADIO CORPORATION  
833 W. Jackson Blvd., Chicago, Dept. J.  
Send me your FREE New 1935 Catalog with the complete Amateur Listing.

Name \_\_\_\_\_  
Address \_\_\_\_\_  
City \_\_\_\_\_ State \_\_\_\_\_

## WHO SAID NO SANTA CLAUS?

An Easy Time Payment Plan for Illinois Amateurs and Servicemen

### HAMS

● McMurdo Silver 5C Recivers

(\$10.00 down—\$8.00 a month)

● Pfanstiehl Single Sideband

(\$7.50 down—\$5.87 a month)

● Patterson PR12

(\$10.00 down—\$8.70 a month)

### SERVICEMEN

● Clough-Brengle Test Equipment  
(Write for payment plan)

We Are Distributors For—

National Union Tubes  
Contental Condensers  
Gold Test Equipment

DEALERS' INQUIRIES SOLICITED  
Write Now, Don't Delay

## WILCOX RADIO SALES

(Dept. R)  
506 S. Wabash Ave. Chicago, Ill.

Send "RADIO" to a friend for one year as a Christmas Gift.



**ELECTRAD  
VOLUME CONTROL**

**Guaranteed  
QUIET!**

REVOLUTIONARY in its operating mechanism and individually tested for noise, Electrad's new Quiet Volume Control fills a long-felt want.

Absolute quiet, smooth, positive control of volume is assured for the first time in radio history.

More even distribution of current and longer life are attained with this construction. Molded Bakelite case, when mounted, projects only one-half inch behind panel. New type power-switch (approved by underwriters) instantly attachable. Long aluminum shaft—easily cut. All standard replacement values.

Write Dept. PR-12 for Descriptive Circular and the New 1935 Resistor Catalog



28 OR 60 M.C. TWIN-TRIODE

- TRANSCIVERS
- DUPLEX UNIT
- TRANSMITTER-RECEIVERS

TYPE 19-A TRANSCIVER, portable, using 2-19's and 30 or 3-19's—\$22.50.  
 TYPE TR-53 DUPLEX UNIT, mobile, transmitter using 41 driver, 53 P.P. Osc., 53 Class B Modulator Receiver using 78 R.F., 37 Det., 37 First A.F., 42 output, \$36.50  
 DYNAMIC SPEAKER, \$3.25, mounted in unit.

Write for Descriptive Literature on Above and AC Operated Units

**Radio Transceiver Laboratories**  
 8427 - 105th Street Richmond Hill, N. Y.

\$1 brings you the next four issues of "RADIO"—Subscribe NOW.

**The RCA Antenna**

The RCA World-Wide Antenna System was developed with two important objects in mind. First, a system was desired which reduced the effects of man-made static. Second, a maximum of signal pick-up over the entire short-wave spectrum was wanted.

THE only principle which has been successfully employed for the reduction of man-made static is to locate the antenna in a comparatively noise free area and to employ a lead-in of such a type that pick-up on the lead-in is eliminated. To place the antenna in a noise free location is a unique problem for each installation. However, the type of lead-in is an important design problem. There are two general types—the shielded lead-in and the balanced transposed line. The shielded line is unsuitable for high frequencies because to be effective, the shielding must be grounded every few feet with short ground wires. This is obviously impossible in most installations.

The balanced line, however, is eminently suitable for many reasons. When used in conjunction with a well-designed transformer at the set pickup on the line is almost completely eliminated. No grounding is necessary. Losses are lower than in a shielded line.

In designing the line the space between the wires and the size of the wires is important. The farther apart they are, and the smaller they are, the higher is the characteristic impedance of the line. If a line is terminated at each end with its characteristic impedance, its transmission is nearly constant at all frequencies. However, when the terminating impedances are widely different from the proper value, the transmission varies greatly with frequency, the curve passing through a series of peaks and valleys corresponding to resonance points in the line.

For the RCA World-Wide Antenna System a line having 180 ohms impedance was chosen because this value is about the average input impedance of most short wave receivers and because it is about the average impedance of the double doublet antenna over the short wave frequency spectrum.

Because the antenna does not represent an

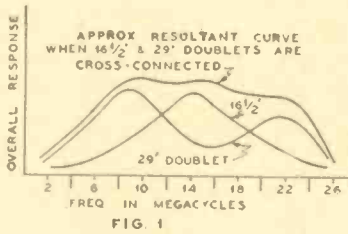

impedance exactly equal to the line impedance at all frequencies, the transmission curve does have a series of minor peaks and valleys, varying in efficiency two or three to one. The line length was adjusted experimentally by throwing short lengths in and out of the circuit, until a length was found such that a transmission peak occurred at each of the important short wave broadcasting bands.

Mechanically, the line consists of a rubber covered twisted pair with stranded tinned copper wire for each conductor. After exhaustive tests special submarine cable rubber was specified for insulation of the transmission line due to its low losses and high natural rubber content. The life of this transmission line is materially increased by the use of this high quality rubber insulation. While twisted pair was indicated to produce a line of the proper impedance, it is also important that the wires be close together with frequent transpositions to avoid picking up out of phase signals.

In order to keep the losses low when the line is wet, it is important that no cotton be

**LITTELFUSES**

Quicker than a short circuit!

Instrument Littlefuses, for meters, 1/200 amp. up.  
 Hi-Volt Littlefuses for transmitters, etc. 1000, 5000 and 10,000 volt ranges, 1/16 amp. up.  
 Neon Voltage Fuses & Indicators (Tattalites) 100, 250, 500, 1,000 & 2,000 volt ratings.  
 Aircraft Fuses, Auto Fuses, Fuse Mountings, etc.  
 Get new Catalog No. 6

LITTLEFUSE LABS., 4503 Ravenswood Ave., Chicago, Ill.

**Calling All Ham Stations**

*Don't Pass Up These Wonderful Bargains*

- G.E. 2 mfd. 2000 DC Working Volt Condensers—fully guaranteed, metal cased with high tension leads 69c
- G. E. 1 mfd. 1000 volt, same as above..... 45c
- 30 Henry 60 Mil Chokes..... 25c
- 30 Henry 100 Mil Chokes..... 39c
- Handy wire assortment, contains 100 wires, assorted lengths stranded and solid—various colored wires 19c
- G.E. 6-tube Power Transformers, 60 cycle, 115 V; 7 Amp. 2 1/2 V; 2 Amp. 5 V; 750 V. center-tap 95c
- All sizes 600 volt tubular mica condensers, .00001 to .02... 06c
- Hammarlund 50 Mmfd. Midgap Variable S.W. Condenser, brass plate 29c
- Genuine Mershon Condensers, 4-8, 17c; 9-9-18-(36) 75c
- 8-8-(16) 49c; 8-8-8-(24) 59c
- Genuine Original Brandes Superior Ear Phones...\$1.39
- RMA CARBON RESISTORS—ALL SIZES—1 watt, 6c
- 2 watt ..... 10c
- CAD-ALLOY—SPOT Welded Rust Proof Cans, 6x6 75c
- All other sizes at equal savings
- S.W. RF Chokes 6c; RCA 100A TYPE Magnetic Units 1.95
- G.E. Toggle Switches, SPST..... 12c
- G.E. Rotary 1/4 Shaft Switches, SPST..... 14c
- G.E. Toggle Switch, long shank, SPST..... 16c
- 4 Band Long-Short All-Wave Cam Switch 1/4" shaft, 21 contact, 4-position. 69c; 13 contact..... 59c
- Output Transformer Windings, 245 push-pull... 25c
- G.E. Single Button Microphone Transformers, 200 ohm to grid ..... 89c
- CRL 500,000 Ohm Volume Control..... 25c
- 5000 Ohm. 19c; 150,000 Ohm..... 29c
- 20,000 and 50,000 Ohm..... 25c

**COIL FORMS**

- 4-prong, 10c
- 5-prong, 17c
- 6-prong, 15c
- 6-tube 2 1/2-volt Filament Transformers..... 49c
- G.E. 10-tube Power Transformers, 25 and 60 cycle—115 V. 11 amps. 2 1/2 V., 2 amp. 5 V. 1120 Volts. CT.....\$2.49
- Double Hammarlund, isolantite padding condensers 19c
- Waver 4-prong Sockets ..... 03c
- 20 Ohm Rheostats, 15c; with knob..... 18c
- 60 Ohm Volume Control with switch for low impedance mike or phono pick up..... 35c
- NO-NOISE Volume Controls, 1M 2M 3M 5M 10M 15M 20M 25M 50, 75, 100, 250M 500,000 1 meg 2 meg. without switch..... 27c
- with switch..... 39c
- 4 Gang TRF .00036 brass plate variable condenser (can be used as a Sonora replacement)..... 69c
- ALL WAVE ANTENNA KIT.....\$2.19
- CROWE AEROPLANE DIAL..... 95c
- Solid Enamel Aerial Wire, No. 14, 34c; No. 12, 43c; No. 10, (100-ft. coils)..... 69c
- Hook-up Wire, solid or stranded, 25 ft., 13c; 50 ft., 23c; 100 ft..... 31c
- Rosin Core Solder..... 10c
- Transposition Blocks..... 05c
- Cad Alloy Metal Panels, won't rust, dulls easy, 7x10, 25c; 7x12, 35c; 7x14, 40c; 7x18... 50c
- 600 V. Mica Condensers, all sizes, .0001 to .006 04c
- TUBES—All Types—50% Discount.

No order less than \$1.00 accepted. C.O.D. order must be accompanied by a 50% deposit. PLEASE INCLUDE POSTAGE. Remit by money order or certified check. No stamps. Quantity limited.

**THE RADIO SHACK**

201 CENTRAL AVE. Newark, N. J.

used as insulation. Even when a cotton wrap is well impregnated, the impregnating material soon evaporates away and moisture then gets in, increasing the line losses.

**The Coupling Transformer**

IT IS very important to note that the noise eliminating feature of the system depends entirely on the design of the transformer which couples the line to the set. The pur-

(Continued on page 41)



## RCA Antenna

(Continued from page 40)

pose of this transformer is to eliminate in-phase signals while transmitting out-of-phase signals. The expression "in-phase" means that the voltages of the two sides of the line go positive together and then go negative together. Obviously, this type of signal will produce no current in the primary of the transformer, it simply changes its potential. "Out of phase" signals are those which cause one side of the line to go negative when the other goes positive and then the reverse. This type of signal does produce primary current. The mere presence of a transformer does not eliminate the in-phase signals, (or noise) because if there is capacity coupling, the noise will be transmitted to the set through that capacity.

In the transformer under discussion a special and highly efficient static shield is used completely eliminating capacity coupling. As a result, the in-phase signals and noise picked up by the line are eliminated while the out of phase signals picked up by the antenna are transmitted to the receiver.

The circuit diagram of the complete antenna system is shown in Fig. 2.

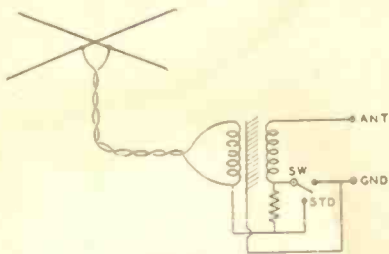

FIG. 2

When the switch is on position marked "SW" operation is as described above. When the switch is on "STD" position the antenna and lead-in both act as antenna. Both in-phase and out-of-phase signals are transmitted together.

A practical test may be made showing that the system does work in this way. When the switch on the transformer is thrown to the position marked "STD" both in-phase and out-of-phase signals are received. If the two sides of the line are shorted it makes very little difference for this connection. When the switch is thrown to the "SW" position the in-phase signals are eliminated, hence if the two sides of the line are shorted the result is almost complete silence.

A resistor is connected from one side of the primary to ground to prevent the antenna system from collecting a high potential and sparking to ground, which would cause disturbing and periodic clicks in the receiver.

## Conclusion

WHEN choosing a noise-free area to locate the "Double Doubler" antenna it is well to keep in mind the generally accepted theory that the strength of noise interference varies inversely as the square of the distance from the source of noise. Since the signal strength of the received broadcast signal is usually considered to increase in a direct proportion to the height above ground the reason for the recommendation to install the "Double Doubler" antenna as high as possible is readily seen. When the RCA World Wide Antenna System is properly installed the signal to noise ratio for short wave reception should be materially increased to allow for more pleasing reception in the average home than heretofore possible.

On short wave signals originating at relatively short distances from the receiver it is often found that greater signal strength is obtained with the "SW-STD" switch in the

(Continued on page 42)

**WHOLESALE WINS BY A KNOCKOUT WITH THE Lafayette XMTR!**

It takes a "pretty good Guy" to win in the Game of Competition these days, but here's the new Lafayette 100 watt Transmitter that performs like a Champion . . . and like all Champions it outshines all contenders. Here's how Public Opinion rated this amazing Low priced XMTR on points . . . up to the knockout that ended all discussion of Superiority!

- ✓ Although conservatively rated at 100 Watts C.W. and 30 watts phone—in actual tests it has consistently delivered 160 watts on C.W. and 40 watts carrier on phone.
- ✓ Suppressor-grid modulation that provides 100% modulation with a minimum of modulating equipment.
- ✓ Crystal Frequency Control—the new "Les-tet" harmonic oscillator, which with a single 2B6 tube provides a stable crystal oscillator and is a very efficient doubler or a neutralizer buffer stage, having more than sufficient output to excite the 100 watt Class C Pentode Amplifier.
- ✓ An Universal Antenna matching unit that permits successful operation on practically any type antenna.
- ✓ Everything is self-contained. Just connect a key, a crystal microphone and antenna. Plug into any 110 V. 60 cycle outlet and operate!
- ✓ Complete Control through use of meters permanently connected in circuit.
- ✓ PRICE—Not only is its initial cost low, but for its rated output it is the most economical transmitter ever offered the Amateur! Comes complete less crystal with one set of coils (choice of 80, 40 or 20 M bands) ..... \$175  
Kit of tubes; 2-RK 20's, 2-2B6's, 1-57, 5-83's ..... \$ 35.44

## BIG FREE CATALOG

(Another Winner)

It, too, is a Champion because it has more pages (192) more items (over 50,000); more nationally known lines (you have to see 'em to believe it!); more specialized departments (Receiver Dept., S.W. Dept., Tube Dept., Public Address Dept., Replacement Parts Dept., Refrigerator Parts Dept., Accessory Dept.) There's a lot more that we could tell you . . . but why not send for your FREE copy now—today—and see for yourself. Of course everything is listed at LOWEST WHOLESALE PRICES!



Wholesale Radio Service Company  
100 Sixth Avenue, Dept. P-124  
New York City

I certainly DO want to tie up to WINNERS! Send me:  
 Your FREE 1935 Catalog No. 56.  
 100 Watt XMTR I have described in letter.

Name .....  
Address .....  
City ..... State .....

**WHOLESALE RADIO SERVICE CO.**  
NEW YORK ATLANTA  
100 Sixth Avenue 430 W. Peachtree St. N.W.  
Local Branch 219 Central Ave., Newark, New Jersey.

Give Your Brother Amateurs a Subscription to "RADIO" as a Christmas Gift. Send Your Orders to "RADIO" Now.

## FOR SALE . . . GOLD MINE!

A GOLD MINE of FACTS! Entire volume of 1934 "RADIO", from January to December. Price \$3.00 complete, plus 75c postage. Eleven of these volumes on hand. If your order is received too late, your money will be refunded.

"RADIO," Pacific Building, San Francisco, Calif.

**NEW RADIO CATALOG**  
Just off the Press! Hundreds of latest developments in Short Wave and 5-Meter parts and accessories. Everything for the Serviceman, Ham, Amateur and Experimenter. Sensational new line of S.W. Receiver Kits from 1 to 5 tubes. RCA-Hazeltine license. Send 10c coin or stamps to partially defray cost of handling and mailing. Get your copy at once.  
**INSULINE CORP. OF AMERICA**  
23-25 Park Place Dept. T-124 New York, N. Y.

# ALAN

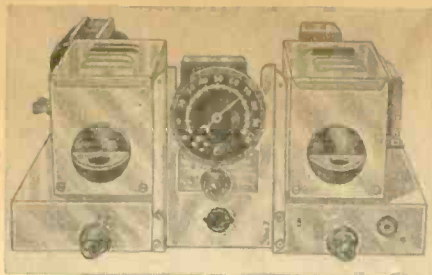

# DR6

## DUAL

## REACTION

Employs six tubes. Dual Reaction circuit using 3—58's; 1—56; 1—2A5; 1—80. Built in power supply—utilizes Alan silva wound, 3-circuit front plug-in coils, phone jack, dual ratio dial, field supply. Completely enclosed in beautiful crackled metal cabinet. Complete kit of parts, including 4 sets of coils, cabinet and complete constructional data; List Price (less tubes and speaker), \$41.60; Net Price to amateurs

**\$24.95**

Wired and laboratory tested additional \$4.50 Net Kit of Sylvania tubes for same \$3.75 Net 8 in. Dynamic speaker to match (Utah, Rola, Magnavox) \$3.50 Net

Order from your nearest source of supply.

**ALAN RADIO CORP.** 172 WASHINGTON STREET, NEW YORK, N. Y. Dept. R. 1  
1028 SOUTH OLIVE ST., LOS ANGELES, CALIF.

## THE SET YOU HAVE ALWAYS WANTED

The "MJ" for the truly critical.

There is no finer all-wave receiver

Write for Details

PIONEER SOUND LABORATORY  
135 Liberty St.  
New York, N. Y.



## NEW—1935 PARTS CATALOG

JUST OFF THE PRESS

IT'S FREE ON

WE STOCK

ALL NATIONALLY ADVERTISED BRANDS and

AMATEUR PARTS ARE OUR SPECIALTY

IF YOUR NAME IS NOT ON OUR MAILING LIST Write for Free Catalog

**CAMERADIO COMPANY**  
603 GRANT ST.  
PITTSBURGH, PA.

## SMITH PRECISION SUPER POWER CRYSTALS TYPE ATY

Unconditionally guaranteed "A cut" crystals at prices others ask for regular crystals. Very low temperature coefficient. Will stand several times the r.f. crystal current permissible with ordinary crystals. Due to special contour, oscillate as freely as any standard X cut or Y cut crystal on the market.

**W. W. SMITH - W6BCX**  
215 West Cook Santa Maria, Calif.  
"Since 1928"

## RCA Antenna

(Continued from page 41)

"STD" position. This is to be expected as the signal being received is probably the ground wave (that portion of the transmission vertically polarized) rather than the sky wave. The ground wave does not develop much signal voltage in the "Double Doublet" but does develop a voltage on the transmission line. Thus since both "in phase" and "out of phase" signals are transmitted with the "SW-STD" switch in the "STD" position greater signal is received from the local short wave broadcasting station at this "STD" position.

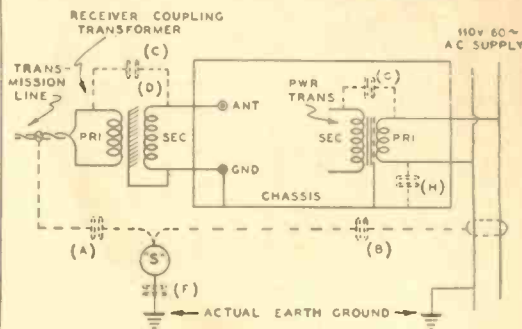

FIG. 3

The receiver coupling transformer of the system eliminates automobile ignition noise completely. This can best be explained by the following paragraphs and illustrated by referring to Fig. 3.

"S" represents a signal generator such as a source of auto ignition noise. (a) represents the capacity coupling from "S" to the transmission line. (b) represents the capacity coupling from "S" to the power supply line. (h) represents the capacity coupling from one side of the power supply line to the metal chassis. (f) represents the capacity coupling from "S" to actual earth ground.

(A) The noise voltage that would be induced by capacity coupling (a) into the transmission line would correspond to an "IN-PHASE" signal and therefore would be coupled or fed through to the secondary of the receiver coupling transformer by the capacity (c) if this capacity (c) were not eliminated by the special and highly efficient electrostatic shield (d). If it were not for shield (d) a noise voltage would be developed across "ANT" & "GND" of the receiver due to a completed circuit from "GND" to chassis frame through "h" to the power supply line which is usually grounded on one side and thence back to "S" through (f).

(B) The noise voltage that would be induced by capacity coupling (b) causes current to flow through the power transformer and develop a noise voltage from ground to the chassis through capacity (h). If no receiver coupling transformer was used this voltage would occur across ("ANT" and "GND") the input terminals of the receiver and hence cause noise. When the RCA World Wide Antenna System is used including the receiver coupling transformer this voltage occurs between the primary and the electrostatic shield since capacity (c) has been eliminated.

However, this does not produce primary current. Therefore this noise voltage does not induce a voltage in the transformer secondary.

(C) The electrostatic shield (j) provided with most power transformers serves to offset the capacity coupling (g) and thus prevents the introduction of RF noise voltages into the voltage supply of the receiver directly.

No doubt the above reasons (A) and (B) contribute to very real improvement in signal to noise ratio to be had with this system on auto ignition interference.

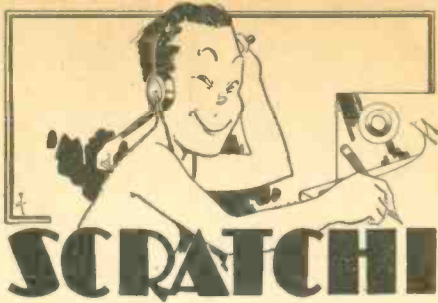

Osockme, Japan, November 11, 1934.  
Honorabull Editor of  
"RADIO":

Scratchi have just return from Pacific Ham Convention. Such round-up are advertised as ham convention but Scratchi find among those present such people as second-hand radio gyys, radio peddlers, ladies and wives, bootleggers and assorted varieties of people. One radio dealer who come to convention in tow car bring with him large stack of wooden canes to give to convention hams. Methinks would be far better for him next year to give away crutches instead of canes, because such would be of much more convenience after convention are over.

While convention are in progress, word leak out that secret meeting were being held in back room by newly formed International Amalgamated Association of Second-Hand Radio Parts Dealers of North America. Such second-hand dealers, as Schatchi have many times find out, are most liberal and kind-hearted people. They are always willing and ready to swap a few pennies' worth of new parts for ten-ton truckload of good used parts. But such second-hand dealers make report to convention that new deal and greater profits make possible for them to give radio hams much better propositions in future and hereafter. Announcement are made by chairman of second-hand dealer association that commencing on January first, next year, and continuing until further notice are given, each second-hand dealer who have joined new association will offer to give to any licensed ham, one brand new, shiny silver dollar in trade for two old ones.

While Scratchi make staggering attempt to walk across convention hotel floor, he are accused of being person who are responsible for putting corn flakes in between bed sheets of political delegates who have come to convention. Hotel manager inform Scratchi that radio ham convention crowd are gentlemen people, and that only one arrest were made during day, not more than seven windows broken and that it are expected by hotel management that fully 50% of hams present would someday pay the hotel bill for rooms and rum.

Included in prize raffle are such as new Comic Pro receiver, also new receivers by McMurder Silver, the new Nertzial H2O, new Sky Slider Stupid 8, new Sargent Marine Models which float, new Patterson and Daughter twelve, new Goodie-Goodie Dozen Super and assorted varieties of accordion antennas, mud coil forms, hard rubber gloves to prevent RF burns, large clubs to make cranky crystals start up, and various contraptions for making life easier for radio inspectors.

Big political meeting are staged on second day. All questions asked by hams are answered in usual manner by salesman who are sent out from Connecticut. He say "maybe yes and maybe no, and sometimes maybe both." All hams at political meeting therefore are given sound advice on all questions which have long troubled them.

Scandal sheet newspaper make appearance at evening frolic. Such newspaper are not copyrighted, Scratchi find with eagles eyes, and therefore permission are not needed to make quote from such paper. One page 1 1/2 are writing which are supposed to be joke. It say that Boarded Directors Meeting at Hartford recently come into session. Seeing such great bundle of people, Warner stick his neck out of window and say—"Look at all my admirers standing outside to greet me." Whereupon which somebody from crowd on street say—"We are not admirers, we are lynching party. HI."

Another bum joke in same paper say that when delicate delegates return from next International Conference and report that there are no changes in ham regulations except that half of present frequencies are to be taken away from hams there are but one thing to do and that are to be non-chalant and light a Murad.

Prize drawing on closing night are huge success. One ham win large transformer which have seen much hard use. Printed notice on such transformer read—"I have enjoyed many a good smoke. Take me home and have one with me."

Scratchi, for first time, are unlucky at prize raffles at convention. Only thing he win are pair of socks which brother ham forget to take home with him when he check out of hotel.

Hoping you have better luck than Scratchi have, I will conclude this letter at the finish, which are now, and I also wish you 73, which I understand are size of collar which you wear.

Sincerely esteemed  
Hashafisti Scratchi.

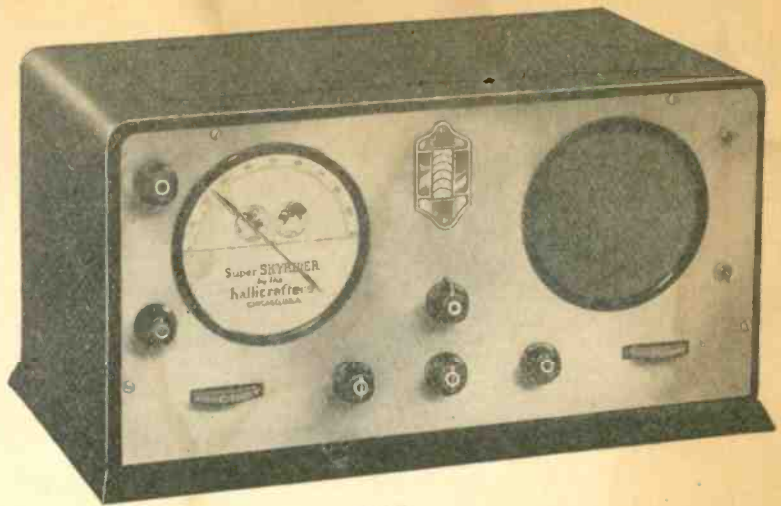

# Again! hallicrafters take the lead in short-wave receiver design

Six months ago the first SKY-RIDER took the short-wave world by storm. Here was performance never before offered even in professional communication receivers costing several times as much. Now another great HALLICRAFTERS Receiver is announced—definitely establishing new standards of Round-the-World reception thrills.

## Built-in Frequency Meter and Monitor

A specially designed circuit makes it possible to use this receiver as both frequency meter and monitor because of the accurate calibration on the large five-inch open face band spread dial. Transmit-Receive switch on front panel has a special control at back of panel that allows proper adjustment for monitoring without blocking the receiver when transmitting.

## SHORT-WAVE TRANSMITTER STANDARDS

The new SUPER SKY-RIDER is built throughout like a short-wave transmitter. It weighs, complete with tubes, over 40 lbs. From the heavy metal cabinet to the low-loss insulation used throughout, the minute signal currents are guarded and economized with the same care as the currents in efficient short-wave transmitters. The result is sensitivity and selectivity that startles even those who have operated the most costly communication receivers. This increased efficiency is added to the fact that HALLICRAFTERS engineers have provided 8 times greater gain in signal strength than offered by previous designs—yet the noise level has been reduced far below that of any other short-wave receiver.

Hallcrafters SUPER SKY-RIDER, seven tube superheterodyne receiver, complete in metal shielding cabinet with built-in power pack, dynamic speaker, and seven tested tubes, net only \$59.95.

## GET FREE DATA ON THESE FEATURES

Pre-selector Stage of Amplification  
Air-tuned I.F. Amplification  
Continuous Band-Spread, plus Easy Logging  
Beat Note Oscillator  
Fractional Micro-volt Sensitivity

No Plug-in Coils  
High Audio Output to Built-in Dynamic Speaker  
Operates Directly from 110 volt A.C. Line Jack on Front Panel for Headphones  
Transmit-Receive Switch on Front Panel

# Super Sky-Rider

## FOR ACTION

Clip and Mail this Coupon Today

Hallcrafters, Inc.  
Dept. R—3001 Southport Ave.  
Chicago, U.S.A.  
Rush me complete free data on the new HALLICRAFTERS Super Sky-Rider and name of nearest jobber who will gladly demonstrate this great new receiver.

Name .....

Address .....

## Latest In "B" Power

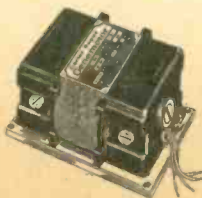

Smallest unit on the market. 2 1/4" wide, 4" high by 5" long. This complete Genemotor furnishes up to 200 volts D.C. Operates from 6 volt storage battery. Ideal for Auto, Airplane or Battery Radios, and Portable Amplifiers.

Write for details and prices on this and other types.

**CARTER MOTOR CO.**

365 W. Superior St.

Chicago, Ill.

## THE BEST IS NONE TOO GOOD



The Trimm Featherweight is not a common headphone. It is a scientifically developed and precision built product. We specialize in solving unusual applications. Let our engineers know your headphone problems. We have a model to meet each need.

**TRIMM RADIO MFG. CO.**

1528 ARMITAGE AVE.

CHICAGO, ILL.

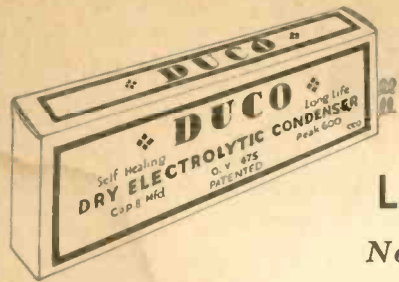

# -DUCO-

"Best by Test"

## Long Life Electrolytics

Now Guaranteed for Two Years

IN NO OTHER CONDENSERS DO YOU FIND THESE FEATURES:

1. Duco condensers are positively self-healing, even up to 3000 volts.
2. Better and longer life than the wet electrolytic condensers.
3. Smaller in size than any other make on the market.
4. For economy in costs it has no equal.
5. DUCO condensers in use over six years showing long shelf and use life.
6. All condensers are rated very conservatively.
7. Growing faster than any other make.
8. Used by best service men in the world.
9. Adopted by finest engineers of set manufacturers.
10. Guaranteed for one year.

DUCO CONDENSERS are fully protected by patents and patent applications all over the world. The response since we introduced our new condenser has been remarkable.

You, too, will be surprised at its performance.

Send for Free Catalog

Sales and Jobber Territory Open

Mfg. by

**DUMONT  
ELECTRIC CO.**

453R Broome Street

New York City, N. Y., U. S. A.

Isolantite Based  
Midget Equalizing  
Condensers Produced  
By Hammarlund



An unusually interesting and efficient midget equalizing condenser has just been developed in the Hammarlund Laboratories, 424 West 33rd street, New York City.

The size of the base is only 5/8 inch by 3/4 inch. It is so light in weight that it is self supporting, in the wiring of any circuit. With its Isolantite base, special mica dielectric, and phosphor bronze springplates, it is an ideal unit for accurate trimming of RF tuning coils, and other similar applications. It is also priced very low.

### "ERRATA"

The following typographical and compository errors inadvertently appeared in Part 2 of the article "Declbels—Technique and Practical Application," published in the November issue of "RADIO."

In the illustration showing the comparison between the 3.5 and 7 watt amplifiers, the input signal level in the 7-watt column should read .0031 mw and NOT .0006 mw, as shown.

In the illustration showing the difference between the 7-watt amplifier with and without the pre-amplifier, the voltage amplification in the Pre-Amplifier column should read 34,776 and NOT 410,005 as shown. In the same column, the input signal voltage should read .011+ and NOT .001+. The output signal level in both columns should read 30.64 and NOT 30.70.



Brings You the Next 4 Issues  
of "RADIO"—Subscribe Now

## THE RME-9D SINGLE SIGNAL SUPER

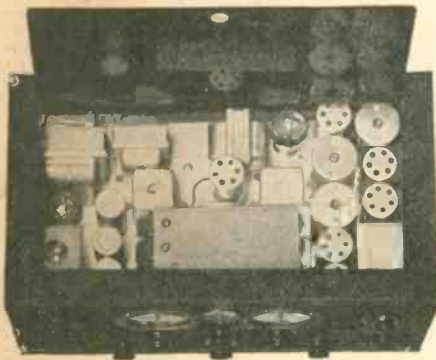

with built-in, high gain rf circuit, rigid coil mountings with change-over switch for band selection, built-in crystal filter with a multiplicity of functions for phone and CW reception,

## PIONEERED

1. the built-in monitor circuit for checking carrier modulation;
2. the built-in bridge-circuit meter to indicate carrier strength of incoming signal, calibrated in R values and microvolts;
3. the built-in resonator to assure peak performance at all times anywhere in the frequency range of the receiver;
4. the six-section variable condenser for high rf gain at all frequencies;
5. the synchronized band-spread of all frequencies, utilizing three section variable capacitor tuning;
6. a completely calibrated receiver in megacycles;
7. the centralization of all controls on the front of the panel;
8. solid, heavy duty, cast aluminum chassis frame.

A Complete Descriptive Folder Sent Upon Receipt of 10 Cents

**RADIO MFG. ENGINEERS**

313 BRADLEY AVENUE

PEORIA, ILLINOIS

You can get the next 4 issues of "RADIO" for only \$1.

When It's Needed in a Hurry!

Servicemen - Amateurs - Experimenters  
Depend on

**BURSTEIN-APPLEBEE CO.**

America's Liveliest Radio House in  
America's Handiest Shipping  
Point.

1012-A McGee St.  
Dept. 181  
Kansas City, Mo.

**1935 CATALOG**  
148  
Pages  
Write us if you  
haven't a copy.

## RADIO ENGINEERING

RCA Institutes offers an intensive course of high standard embracing all phases of Radio. Practical training with modern equipment at New York and Chicago schools. Also specialized courses and Home Study Courses under "No obligation" plan. Illustrated catalog on request.

**RCA INSTITUTES, INC., Dept. RA-34**  
75 Varick St., N. Y. 1134 Merchandise Mart, Chicago  
Recognized Standard in Radio Instruction Since 1909



### STATEMENT OF OWNERSHIP, MANAGEMENT, CIRCULATION, ETC., REQUIRED BY THE ACT OF CONGRESS OF AUGUST 24, 1912.

"RADIO" published monthly at San Francisco, Calif., for October 1, 1934  
State of California,  
County of San Francisco

ss. Before me, a Notary Public in and for the State and County aforesaid, personally appeared H. W. Dickow, who, having been duly sworn according to law, deposes and says that he is the Business Manager of "RADIO" and that the following is, to the best of his knowledge and belief, a true statement of the ownership, management, etc., of the aforesaid publication for the date shown in the above caption, required by the Act of August 24, 1912, embodied in Sec. 411, Postal Laws and Regulations, to wit:

1. That the names and addresses of the Publisher, Editor, Managing Editor, and Business Managers are:

Publisher—Pacific Radio Publishing Co., Pacific Bldg., San Francisco, Calif.; Editor—Clayton F. Bane, Pacific Bldg., San Francisco, Calif.; Managing Editor—None; Business Manager—H. W. Dickow, Pacific Bldg., San Francisco, Calif.

2. That the owner is:  
Pacific Radio Publishing Co., Pacific Bldg., San Francisco, Calif.; H. W. Dickow, Pacific Bldg., San Francisco, Calif.

3. That the known bondholders, mortgagees, and other security holders owning or holding 1 per cent or more of total amount of bonds, mortgages, or other securities are:

None.

4. That the two paragraphs next above, giving the names of the owners, stockholders, and security holders, if any, contain not only the list of stockholders and security holders as they appear upon the books of the company, but also, in cases where the stockholder or security holder appears upon the books of the company as trustee or in any other fiduciary relation, the name of the person or corporation for whom such trustee is acting is given; also that the said two paragraphs contain statements embracing affiant's full knowledge and belief as to the circumstances and conditions under which stockholders and security holders who do not appear upon the books of the company as trustees, hold stock and securities in a capacity other than that of a bona fide owner; and this affiant has no reason to believe that any other person, association, or corporation has any interest, direct or indirect, in the said stock, bonds, or other securities than as so stated by him.

**H. W. DICKOW,**  
Business Manager.

Sworn to and subscribed before me this 4th day of October, 1934.

(Seal) **JOHN L. MURPHY,**  
Notary Public in and for the City and County of San Francisco, State of California. My commission expires May 20, 1937.

**In STOCK**  
for immediate  
Shipment

**THE NEW RCA  
ACR-136 RECEIVER**

See RCA advertisement in this issue for illustration and complete description. Write us for special bulletin describing the ACR-136 Receiver.

Ask  
for  
FREE  
Catalog

**NEWARK  
Transmitting Condensers**

All enclosed in black crackle finish metal case. Angle mountings. Paper condensers. Porcelain insulated leads. A real value.

1 mfd—1000 working volts D.C. Size 3" x 1 3/4" x 4". Wt. 1 1/2 lbs. **95c**

1 mfd—1500 working volts D.C. Size 3" x 2 3/4" x 4". Wt. 2 lbs. **\$1.29**

2 mfd—1500 working volt D.C. Size 3 3/4" x 4" x 5". Wt. 4 1/4 lbs. **\$2.19**

**NEWARK ELECTRIC CO.**

226 W. MADISON ST., Dept. R.

CHICAGO

**Greater Power with  
GRAPHITE ANODES**

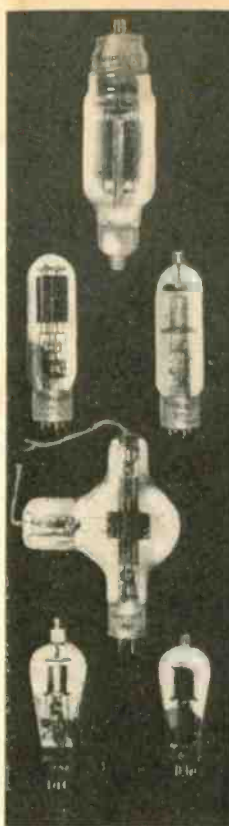

The Cooler Operation of Amperex Power Tubes—because of the greater surface and black body radiation of the Graphite Anodes results in longer life and greater power output.

800	—	\$ 10.00	List Price
203A	—	15.00	List Price
211	—	12.50	List Price
210	—	3.00	List Price
830	—	8.75	List Price
845	—	17.50	List Price
852	—	22.50	List Price
860	—	35.00	List Price
866A	—	5.00	List Price
872	—	15.00	List Price
872A	—	17.50	List Price
204A	—	95.00	List Price
849	—	160.00	List Price

Dealers write for complete catalog and discounts

**AMPEREX ELECTRONIC  
PRODUCTS, INC.**

79 Washington St., Brooklyn, N. Y.

**AMPEREX**  
Power Tubes •

**BUILD FOR YOURSELF  
THE NEW LINCOLN "CQ"**

The first highly engineered custom built receiver available IN KIT FORM

NOW, for the first time you can build and own one of these Lincoln engineered receivers at the cost of just the parts only. We are passing on to you absolutely free the complete engineering and construction data with each set of parts. The Lincoln "CQ" is not just an assembly of stock parts, it is the finest piece of engineering ever put out in the Lincoln Laboratory.

- HIGH GAIN R.F. STAGE—ALL BANDS
- NEW PI WOUND HIGH SELECTIVITY I.F. TRANSFORMERS
- ALL COILS INDIVIDUALLY SHIELDED
- ALL COILS, I.F. INCLUDED, WOUND ON ISOLANTITE AND CERAMIC FORMS
- FIVE BANDS, LOW L C RATIO, HIGH GAIN
- EIGHT TUBES IN RADICALLY NEW CIRCUIT
- NINE TUNED CIRCUITS

See your local jobber at once, or write to the Lincoln Radio Corporation for complete details and prices on complete built chassis in our laboratory or complete C-Q parts and full construction data.

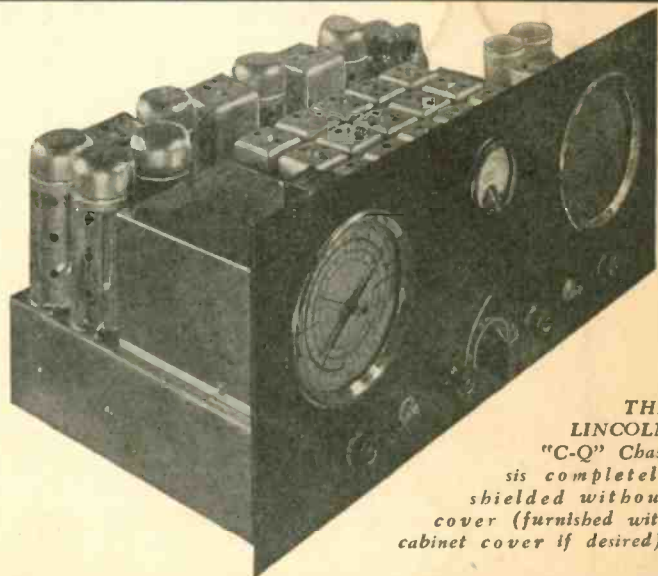

THE  
LINCOLN  
"C-Q" Chassis completely shielded without cover (furnished with cabinet cover if desired).

This message is being presented to the most intelligent radio audience—Men who know radio and who have contributed much towards the art of successful radio communication. I do not know of any angle of the radio game in which I am more interested than the Amateur Bands. In years of building highly engineered high priced equipment for the critical BCL and many receivers for communication work, I have tried to put into the new Lincoln "C-Q" every bit of the past knowledge, coupled with new possibilities and new tubes with very startling results. Putting this equipment into kit form has opened up an entirely new channel, whereby you can couple your expert ability in building with our many past years of experience in engineering and designing. To the old timer, I know the new "C-Q" is going to widen out your range, reduce your QRN and QRM and give you more five and nine signals. To the new "ham" just coming on the air, you can start at low cost with a quality custom built receiver.

W. H. HOLLISTER, President.

**LINCOLN RADIO CORPORATION**  
2222 Diversey Ave. Dept. R-10 Chicago, Illinois

Radio Dealers and Jobbers who desire to advertise in these columns are invited to write for rates.

# RADIO BUYERS' GUIDE

A Monthly Listing of Reliable Radio Dealers and Jobbers who solicit the patronage of our readers. Buy from your nearest Dealer or Distributor. He is dependable and reliable.

CHICAGO, ILLINOIS

## Chicago Radio Apparatus Company, Inc.

415 South Dearborn Street  
Harrison 2276

Dependable Radio Equipment  
Established 1921

Bulletins on request—we specialize in short wave transmitting and receiving apparatus.  
\* Catalog Ten cents.

CHICAGO, ILLINOIS

## MID-WEST RADIO MART

520 South State Street  
CHICAGO

Write for Special Catalog—Free

CHICAGO, ILLINOIS

## Newark Electric Company

226 W. Madison St.  
Chicago

All Kinds of Equipment for  
Service Men - Amateurs - Experimenters  
Write for free catalog

## OAKLAND, CALIFORNIA RADIO SUPPLY CO.

2085 BROADWAY.

Hammarlund, Yaxley, Carter, National, Johnson, IRC, Cardwell, Miller, Morrill, Flechteim, Triplett, Haigis Transceivers  
W6GFY

ST. PAUL, MINNESOTA

## LEW BONN COMPANY

2484 University Avenue

Rex L. Munger, W9LIP, Sales Engineer

Radio Wholesaler

Complete Stock

BUFFALO, N. Y.

## DYMAC RADIO

216 E. Genesee St.

CL 2080

Complete Stock Amateur Parts  
STANDARD DISCOUNTS

—W8AWK—

LOS ANGELES, CALIFORNIA

## RADIO SUPPLY CO.

912 SO. BROADWAY

The Amateurs'  
HEADQUARTERS of the WEST

All Nationally Advertised Parts for  
Receiving and Transmitting carried  
in stock at all times.

9 Licensed Amateurs on Our Staff



## NEW PRODUCTS

### Aladdin Resonator

THE Aladdin Resonator consists of a flexible rubber rod with a small Poly-iron core at one end and a brass insert at the other end.

The resonator is used to determine whether an inductance is below or above the required value for resonance. Insert one end of the Aladdin Resonator in the field of the inductance. If the inductance is above the resonant value, the insertion of the end having the brass insert will decrease the inductance to the resonant value, while if the inductance is low, the insertion of the end having Poly-iron core will increase the inductance to the resonant value. The flexible rubber rod facilitates insertion of either plug in difficult places.

In checking performance of a receiver without the Aladdin resonator, it is necessary to adjust the trimming condensers, and each adjustment only products resonance at a single frequency, and does not satisfactorily indicate whether the inductances are of the correct value. The trimming condensers are usually adjusted at the highest frequency in the factory and the resonant condition remains substantially correct for that particular frequency, but if the inductances are not of the right value the receiver will not track satisfactorily. It requires at least two adjustments of trimming condensers to determine whether the inductances are too high or low and after this has been determined, it is again necessary to realign the trimming condensers for the highest frequency setting.

With the Aladdin resonator, this laborious work is eliminated. All that is necessary is to first determine whether the trimming condensers are adjusted to resonance at the proper high frequency setting, then tune to a low frequency, and insert the Aladdin Resonator in the field of each coil to determine whether the inductance is high or low. If the inductance is high, it is possible, in the majority of coil forms, to space a few turns farther apart, while if the inductance is low, the turns may be brought closer together.

The Aladdin Resonator is of great assistance to inspectors, experimenters and service men. It will instantly tell whether any tuning inductance is correct, or high, or low, and immediate replacement of modification of incorrect units will speed up repair or final acceptance of the receiver. The Aladdin Resonator can be used at frequencies as high as 25 megacycles, because the losses in the Poly-iron cores even at these high frequencies, are extremely low.

Manufactured by Aladdin Radio Industries, Inc.,  
4049 W. Diversey Street, Chicago, Illinois.

### Aerovox Oil Filled Xmtr Condensers

DESIGNED for performance rather than price, a new line of oil-filled, oil-impregnated transmitting condensers is announced by the Aerovox Corporation, Brooklyn, N. Y.

The units are available in round and rectangular metal cans, in either case with high-tension insulator post terminals.

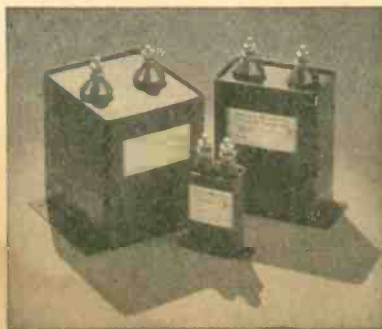

CHICAGO, ILLINOIS

## Chicago Radio Apparatus Company, Inc.

415 South Dearborn Street  
Harrison 2276

Dependable Radio Equipment  
Established 1921

Bulletins on request—we specialize in short wave transmitting and receiving apparatus.  
Catalog Ten cents.

PITTSBURGH, PENNSYLVANIA

## CAMERADIO COMPANY

603 Grant Street

Tri-State "Ham" Headquarters  
Standard Apparatus Standard Discounts

FRESNO, CALIFORNIA

## PORTS MANUFACTURING CO.

3265 E. Belmont Ave. Radio W6AVV  
National FB7-SW3 and Parts; Hammarlund, Cardwell, Bliley Crystals; Johnson Insulators.  
Distributors RCA-DeForest Transmitting Tubes  
Established 1914 Send for Wholesale Catalog

SAN FRANCISCO, CALIFORNIA



1452 Market Street.

"The House of a Million Radio Parts"

Hammarlund and National sets and parts.  
Sylvania Amateur Transmitting Tubes

Collins Transmitters.

Arcturus Receiving Tubes.

Trimm Phones, all types.

Johnson Antenna Feeders, Insulators,  
Transposition Blocks.

SEATTLE, WASHINGTON



## LARGEST PARTS SUPPLY DEPOT IN THE NORTHWEST

Four of Our Employees Are Licensed

W7BRS

Amateurs

W7CR

W7AVC

W7WE

CORNELL DUBILIER, BLILEY, PATTERSON  
SETS, COLLINS, WARD, LEONARD,  
UNITED TRANS.

SCHENECTADY, NEW YORK

## Eastern Radio Supply Company

712 Broadway

Wholesale Distributors of  
Tubes, Parts, and Test Equipment for  
Service Men - Amateurs - Experimenters  
Write for Quotations

# World's Greatest Values in Radio Receivers for 1935

Each model of the 1935 Crosley line represents the utmost in beauty and performance in its respective price field. Therefore Crosley dealers give the most for the money in any price range from a beautiful table model at \$19.99 to a gorgeous console at \$99.50. The American-Foreign and 3-Band All Wave models are exceptional values. Your nearest Crosley distributor will give you full details.

## THE CROSLY FIVER

Five Tubes . . . Superheterodyne . . . One Dual Purpose Tube . . . (6-tube efficiency) Illuminated Dial . . . Full Floating Moving Coil Electro-Dynamic Speaker . . . 540 to 1740 Kc. . . Standard Broadcasts and some police calls.

**\$19.99**  
complete

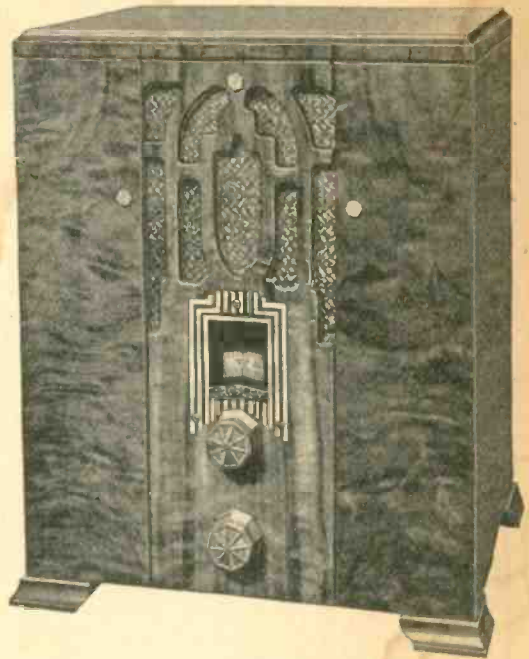

## AMERICAN-FOREIGN AND ALL WAVE MODELS at lowest prices



**Sixty-One A. F.**  
Eight-tube effectiveness, airplane type dial, automatic volume control, 3-gang tuning condenser, distinctive cabinet.  
**\$39.95**



**614EH 3-Band All Wave**  
Two double purpose tubes provide 8-tube effectiveness. Many distinctive features. Outstanding quality of tone and performance. Low in price.  
**\$49.95**



**Seventy-Two A. F. (Lowboy)**  
A 7-tube American-Foreign receiver. Uses same chassis as Seventy-Two A. F. Covers standard broadcasts from 540 to 1700 Kc. and Foreign broadcasts 5800 to 15,300 Kc. Exquisite cabinet.  
**\$79.50**

**Seventy-Two A. F.**  
Airplane type dial, automatic volume control, continuous tone control, 10-tube effectiveness.  
**\$59.95**



**714GA 3-Band All Wave**  
Same cabinet as above. 3-Band receiver for American-Foreign, police, amateur, aviation reception.  
**\$65.00**

**814FA All Wave**  
Illuminated airplane type dial, dual ratio tuning control, automatic volume control, push-pull output, continuous tone control. Gorgeous cabinet.  
**\$79.50**

**Sixty-Four MD (Lowboy)**  
Uses same chassis as Sixty-One A. F. Covers standard broadcasts from 550 to 1700 Kc. and Foreign broadcasts 5,800 to 15,300 Kc. Many distinctive features.  
**\$54.50**



**614PG 3-Band All Wave (Lowboy)**  
Uses same chassis as 614 EH. Covers standard broadcasts from 540 to 1650 Kc., police, amateur, aviation 1650 to 5000 Kc., Foreign 5800 to 15,300 Kc.  
**\$65.00**



**714NA 3-Band All Wave (Lowboy)**  
An all wave, seven tube, 3-band receiver in the cabinet shown at right. Uses same chassis as 714 GA.  
**\$85.00**



**814QB All Wave (Lowboy)**  
An all wave receiver. 530 to 24,000 Kc. Houses same chassis as 814FA. A superbly beautiful cabinet. The ultimate in all wave reception. Attractive in price.  
**\$99.50**



Montana, Wyoming, Colorado, New Mexico and west, prices slightly higher.

## THE CROSLY RADIO CORPORATION

Home of "the Nation's Station"—WLW—500,000 watts—most powerful in the world—70 on your dial.

POWEL CROSLY, Jr., President

CINCINNATI

WHATEVER HAPPENS . . . YOU'RE THERE WITH A CROSLY  
**CROSLY RADIO**



PIONEERS NEW

# Universal Modulation Output Chokes

JNA Hawkins, who originally sponsored this type of modulation coupling, says, "This choke will be a life-saver in every phone station in the country, as well as most labs. The combination of taps seems to take care of every impedance ratio that I have been able to find after laying out innumerable amplifier setups." This type of modulation choke is fully endorsed by leading phone men.

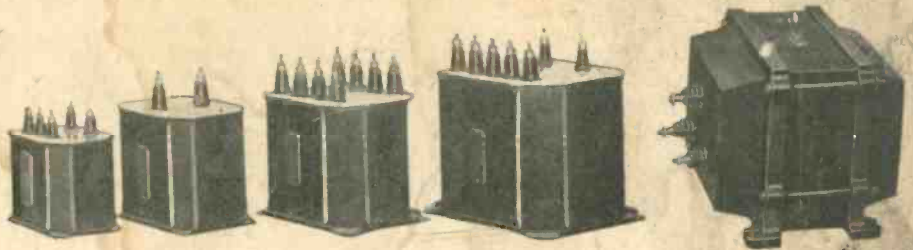

## WHAT THIS UNIVERSAL MODULATION CHOKE WILL DO:

It is tapped so that it can be used as an autotransformer coupler from Class B to Class C stages; various impedance taps are available so that each choke will readily accommodate push pull Class A-Prime or Class B Modulators, single ended Class A Modulator with the DC adding, or single ended Class A Modulator with the DC bucking. The chokes are huskily constructed and air gaps are arranged to take care of the maximum DC currents.

TYPE		LIST PRICE	NET TO HAMS
HUC-20	Will handle 20 watts audio power. Can be used with class B 46's, 59's, 53, 6A6, 79, etc., or class A 2A3's, class A prime 42's, 45's, etc.	\$7.00	\$4.20
HUC-50	Will handle 50 watts audio power. Suitable for use with class B 210's, 801's, 830's, 841's, push pull parallel 46's or 59's, push pull parallel 45's A prime, push pull parallel 2A3's.	\$12.50	\$7.50
HUC-100	Will handle 100 watts audio power. Suitable for use with class B 800's, 211E's, A prime 284's, 845's, etc.	\$20.00	\$12.00
HUC-200	Will handle 200 watts audio power. Suitable for use with class B 203's, 830B's, HK-854's, single EIMAC 150T, push pull parallel 845's, prime, etc.	\$32.50	\$19.50
HUC-500	Will handle 500 watts audio power. Suitable for use with class B 204's, HK354's, EIMAC 150T's, A prime 212D's, A prime 849's, etc.	\$80.00	\$48.00

## High Quality Public Address Audio Components



45A Prime Amplifier—Protective Cover Removed

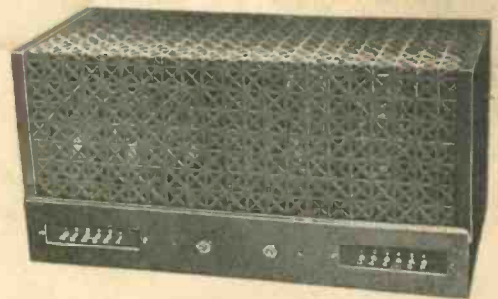

45A Prime Amplifier with Protective Perforated Cover

For a Parallel Push Pull 45A Prime Amplifier

- Ideal for broadcasting, recording, and public address applications. Will drive output amplifiers modulating up to 500 watts A.F. into R.F. stage. ● High power output with low cost power tubes.
- Input will match 50, 200, and 500 ohm lines. Center tap on 200 and 500 ohm lines for double button microphone.
- Output will match 500, 200, 16, 8, 5, 3, and 1.5 ohms.
- Three balanced push pull audio stages. Tubes used: 2-57's triode connected, 2-56's, 4-45's in parallel push pull fixed bias, 1-83, 1-45.
- Stable fixed C bias for output stage.
  - Undistorted class A prime output 38 Watts.
  - Gain + 90 D B.

UTC Public Address Type components used are:

	List Price	Dealer's Price
1—PA-135—500, 200, or 50 ohm line to push pull grids.	\$ 7.50	\$ 4.50
1—PA-138—triode 57 plates to 56 grids.	6.00	3.60
1—PA-233 drives 56 plates to 45 grids.	6.00	3.60
1—PA-445—A prime push pull parallel 45 output or self bias.	12.50	7.50
1—PA-103—A prime input swinging choke.	8.00	4.80
1—PA-102—Output trap resonant smoothing choke.	8.00	4.80
1—PA-425—Heavy duty A prime 45 plate filament and C bias transformer.	12.00	7.20
1—PA-45—High impedance C bias choke.	4.50	2.70
1—Heavy Gauge drilled deck and protected perforated cover.	12.75	7.65
	\$77.25	\$41.35

Trap resonant filter aords maximum filtering efficiency.

Write for the new U-1100A Manual. 24 pages devoted to basic amplifier circuits, including fundamental charts on attenuation network data, decibel charts, reactance charts, rectifier constants and class B circuit constants.

Send 10 stamps to cover mailing charges.

# UNITED TRANSFORMER CORP.

264-266 CANAL STREET

Export Division, 15 Laight St., New York, N. Y.

NEW YORK, N. Y.

Exclusive UTC distributors carrying a complete stock of UTC products.

Goldhamer's, Inc.	610 Huron Road, Cleveland, Ohio	W. H. Edwards & Co.	32 Bway, Providence, R. I.
Wholesale Radio Service Co., Inc.	100 Sixth Ave., New York, N. Y.	SEATTLE, WASH.—Seattle Radio Supply Inc.	2319 Second Ave.
Wholesale Radio Service Co., Inc.	219 Central Ave., Newark, N. J.	Portland Radio Supply Co.	1300 W. Burnside, Portland, Ore.
Wholesale Radio Service, Inc.	430 W. Peachtree St. N. W., Atlanta, Ga.	Spokane Radio Co., Inc.	611 First Ave., Spokane, Wash.
Sun Radio.	227 Fulton Street, New York, N. Y.	San Francisco Radio Exchange	1284 Market St., San Francisco, Calif.
William Gram	1444 Sheridan St., Lansing, Mich.	SOUTHERN CALIFORNIA	
Mohawk Electric Co.	1335 State St., Schenectady, N. Y.	Pacific Radio Exchange Inc.	729 S. Main St., Los Angeles
Walter Ashe	1100 Pine St., St. Louis, Mo.	Radio Supply Co.	912-14 S. Broadway, Los Angeles
Radio Shack	46 Brattle St., Boston, Mass.	Coast Electric Co.	744 G. St., San Diego
Nutter & Cross	990 Milk St., Boston, Mass.	Preat & Dean Radio Co.	400 American Avenue, Long Beach
Radio Service Lab. of N. H.	1008 Elm St., Manchester, New Hampshire	Radio Television Supply Co.	1701 S. Grand Ave., Los Angeles, Calif.
Hatry & Young	203 Ann St., Hartford, Conn.	Radio Specialties Co.	1816 West 8th St., Los Angeles, Calif.